

Acquastop

Sistema anti-allagamento

Istruzioni per il montaggio,
l'uso e la manutenzione



Indice

pag. 3 - Note importanti sul funzionamento di Acquastop

pag. 5 - Contenuto della scatola

pag. 6 - Taglio dei galleggianti

pag. 7 - Guide modello per modello

pag. 21 - Installazione

pag. 24 - English

pag. 46 - Deutsch

pag. 68 - Français

pag. 90 - Español

pag. 112 - Nederlands

pag. 134 - Ελληνική

pag. 156 - Türkçe

Note importanti sul funzionamento del sistema Acquastop

Il sistema anti-allagamento Acquastop di Lucernario Aerante previene l'allagamento della bocca di lupo (o cavedio) qualora la rete di scarico fosse otturata. Acquastop agisce con l'aumento del livello dell'acqua all'interno del fossetto di ventilazione. Le staffe-guida hanno il compito di guidare Acquastop dalla posizione orizzontale di riposo alla posizione verticale di lavoro, che chiude il passaggio dell'aria, impedendo l'ingresso dell'acqua negli ambienti sottostanti.



La chiusura delle prese d'aria è efficace ma non totale, gocce e piccoli rigagnoli d'acqua possono passare anche quando l'Acquastop ha raggiunto la posizione di lavoro. Dopo ogni fenomeno è necessario riportare manualmente Acquastop in posizione orizzontale di riposo.



Malfunzionamenti possibili

Il sistema antiallagamento Acquastop non è infallibile. Ci sono alcune condizioni che possono impedire il corretto funzionamento del sistema, ma si possono prevenire con delle piccole manutenzioni da eseguire periodicamente.

Pulizia

Lo sporco che si accumula nel fossetto di ventilazione di Lucernario Aerante può essere d'intralcio al galleggiante di Acquastop durante il suo percorso verso la posizione di lavoro. Foglie, sassi, aghi di pino o pelo d'animale possono depositarsi all'interno del fossetto di ventilazione e possono impedire il corretto funzionamento di Acquastop. Pulire periodicamente il canale di raccolta dello sporco è indispensabile per prevenire un malfunzionamento del sistema antiallagamento Acquastop.

Sedimenti appiccicosi che trattengono il galleggiante

Può verificarsi che il galleggiante di Acquastop, se rimasto in posizione di riposo per troppo tempo, si appiccichi al fondo del fossetto di ventilazione del Lucernario Aerante e rimanga trattenuto nel momento in cui è necessario che si alzi per portarsi in posizione di lavoro. Quando si effettua la pulizia periodica del fossetto di ventilazione è necessario muovere il galleggiante per assicurarsi che nulla lo trattenga in posizione orizzontale di riposo.

Fenomeni atmosferici avversi

Il sistema antiallagamento Acquastop è stato ideato per prevenire danni a fronte di un allagamento dovuto a condizioni atmosferiche avverse, tuttavia sono infiniti i possibili risvolti che un evento atmosferico può avere e non è possibile prevedere, né escludere, che durante un'alluvione, tempesta o allagamento, l'acqua porti con sé detriti o fango che blocchino il percorso del galleggiante rendendo nullo il suo funzionamento.

In foto il banco prova di Acquastop

Contenuto della scatola

Galleggiante

6

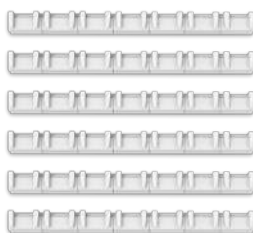

Staffa-guida

12

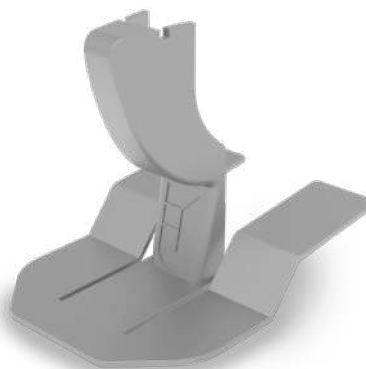

Taglio dei galleggianti

Step 1 - Individuare il proprio modello di Lucernario Aerante INOX



Modello	Dimensioni	
XS55	55	130
XS85	85	130
S65	65	150
S85	85	150
M65	65	170
L65	65	190

Modello	Dimensioni	
XS66	66	130
XS96	96	130
S76	76	150
S96	96	150
M76	76	170
L76	76	190

Step 2 - Istruzioni generali di taglio

COME TAGLIARE

Individuare la linea di taglio sul galleggiante.
Appoggiarsi su una superficie piana, con una lama affilata, praticare un taglio pulito e dritto.

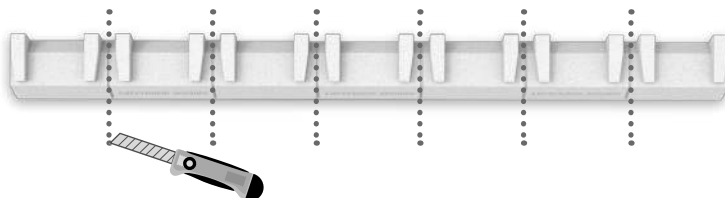

DOVE TAGLIARE

Continua la guida modello per modello

Modello XS55

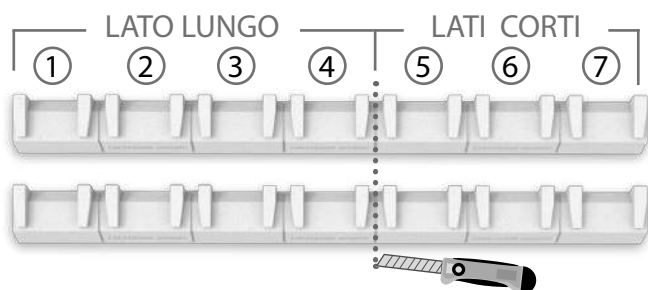

2

Gallezzanti
da tagliare

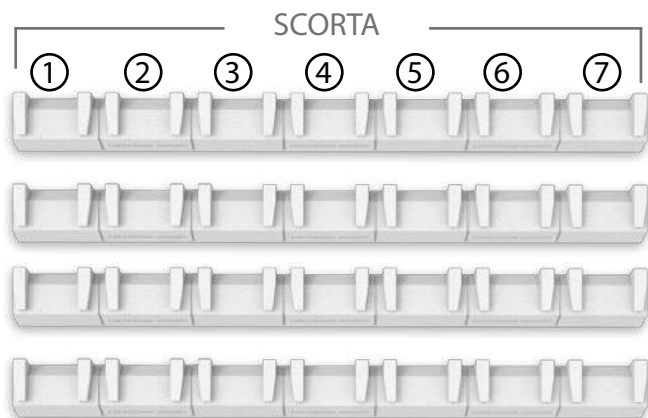

Modello XS85

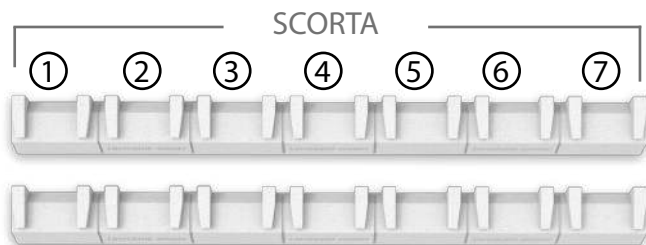
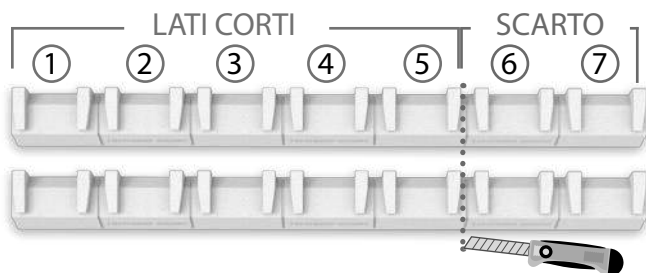
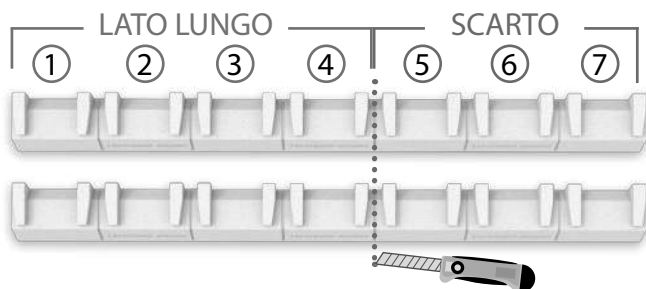

4

Galleggianti
da tagliare

Modello S65

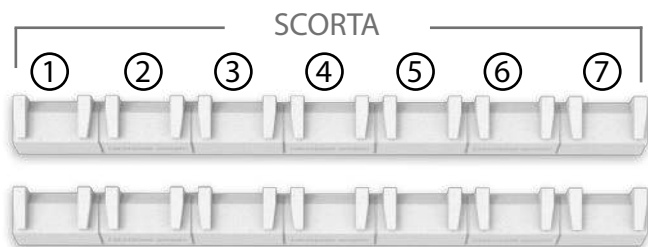
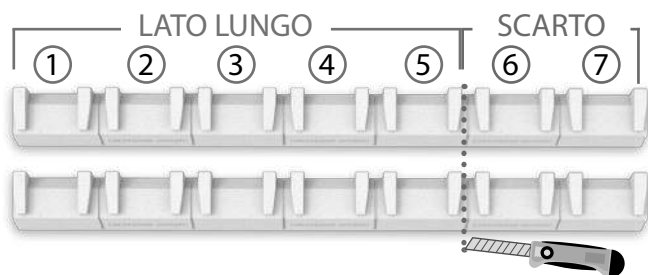
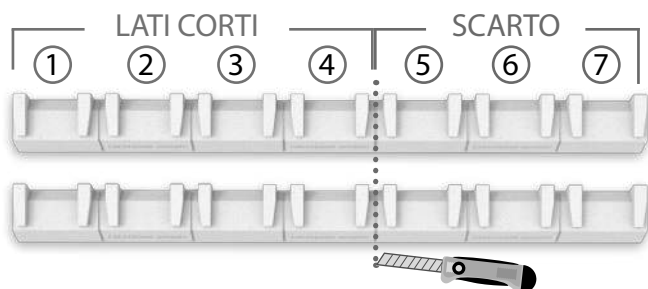

4

Galleggianti
da tagliare

Modello S85

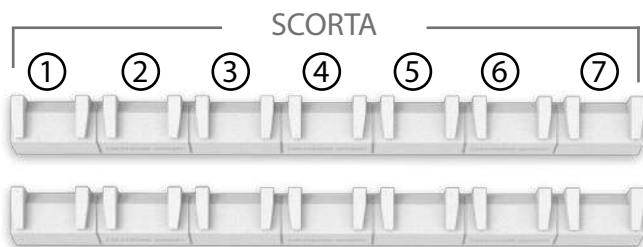
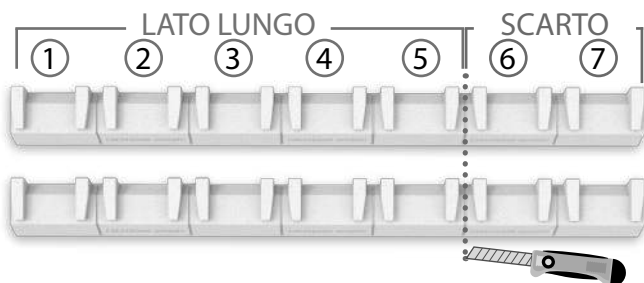
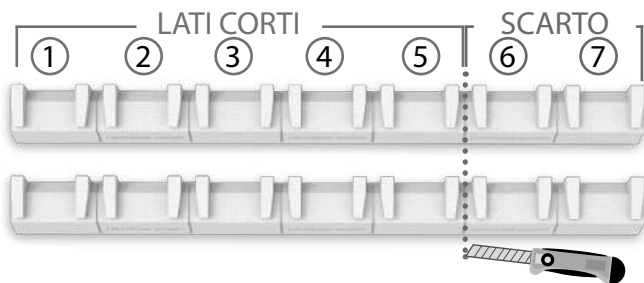

4

Galleggianti
da tagliare

Modello M65

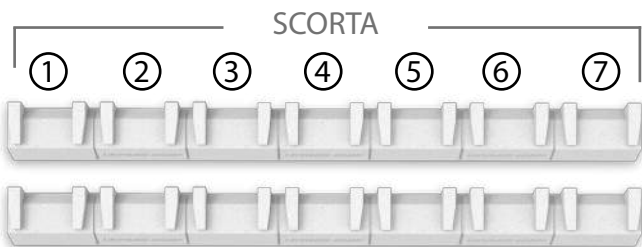
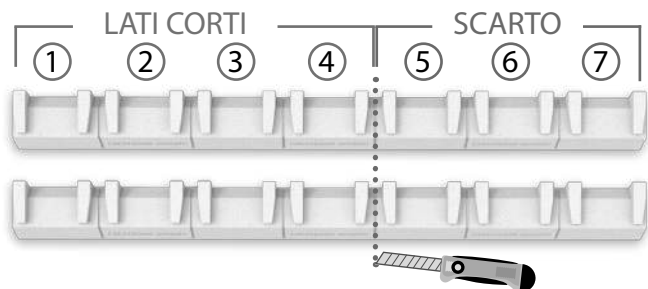

4

Galleggianti
da tagliare

Modello L65

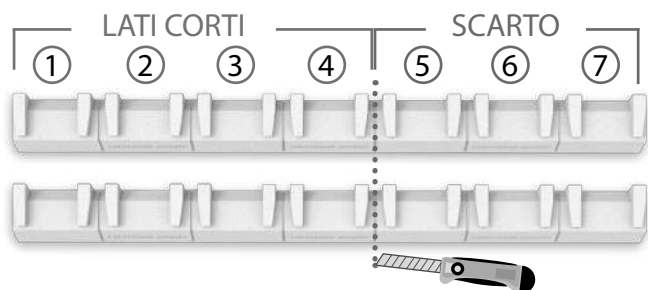

2
Galleggianti
da tagliare



2
Galleggianti
interi

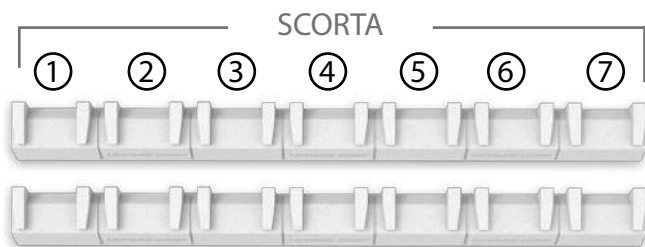

Modello XS66

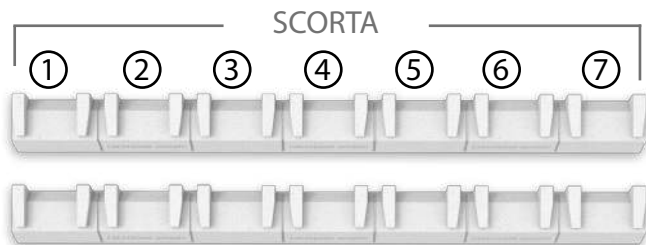
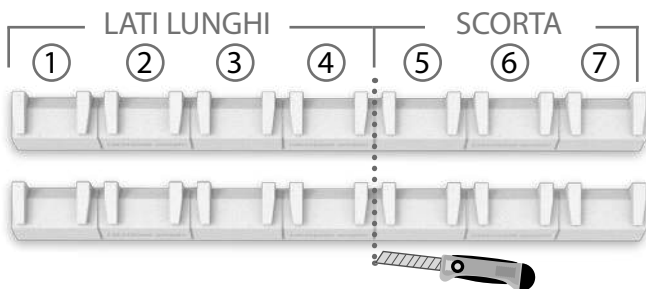
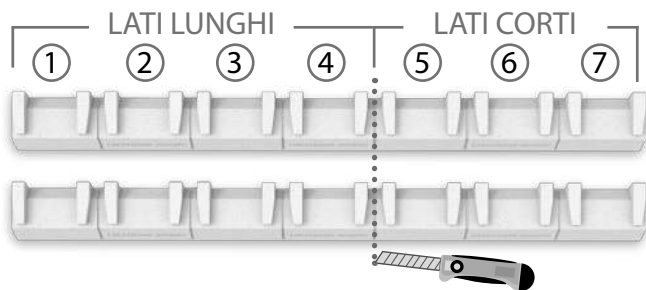

4

Galleggianti da tagliare

Modello XS96

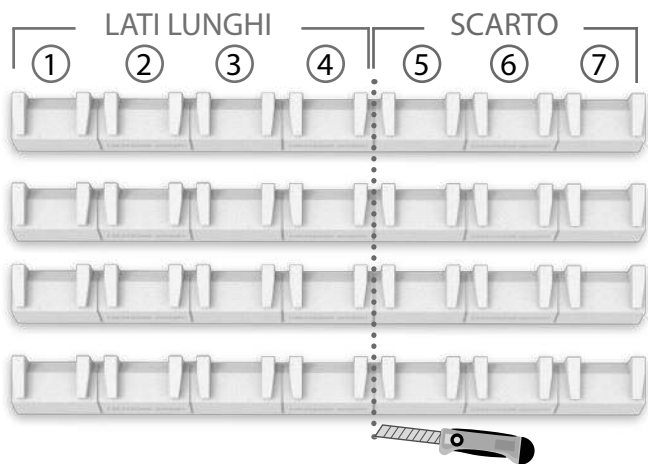

6

Galleggianti
da tagliare

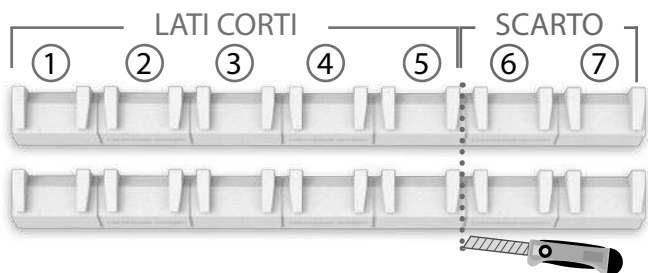

Modello S76

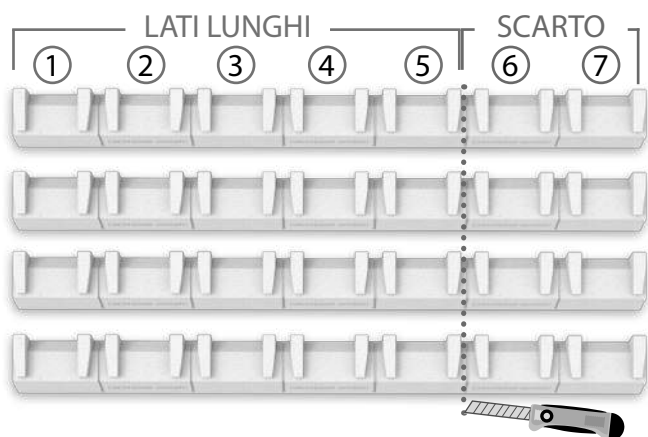
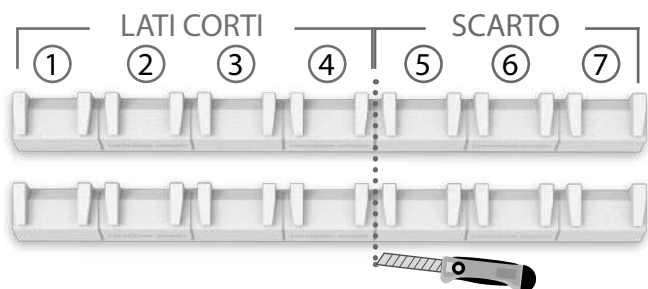

6

Galleggianti
da tagliare

Modello S96

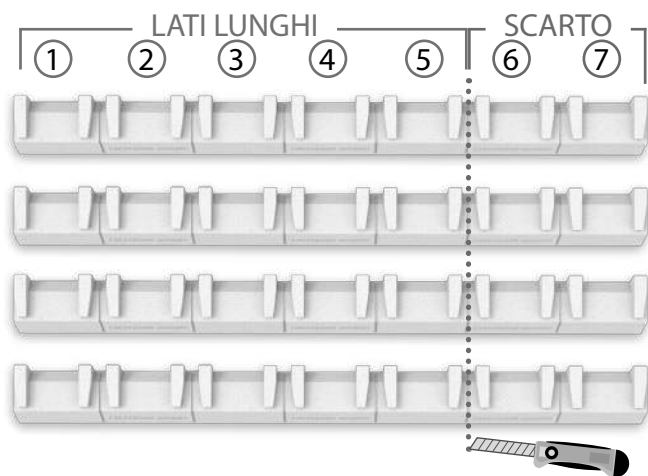
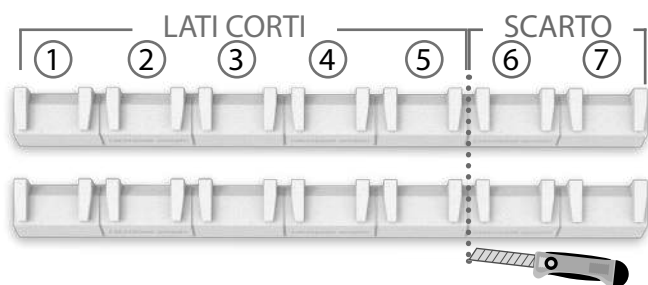

6

Galleggianti
da tagliare

Modello M76

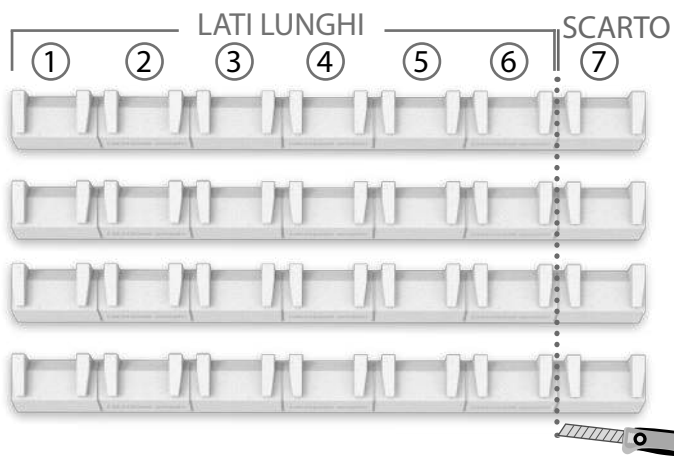
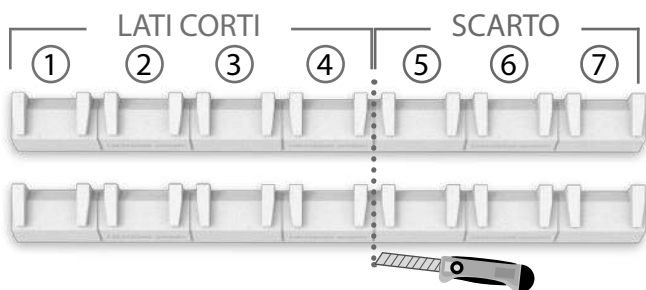

6

Galleggianti
da tagliare

Modello L76

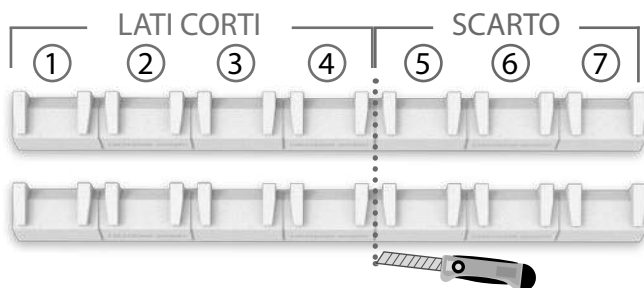

2

Galleggianti da tagliare

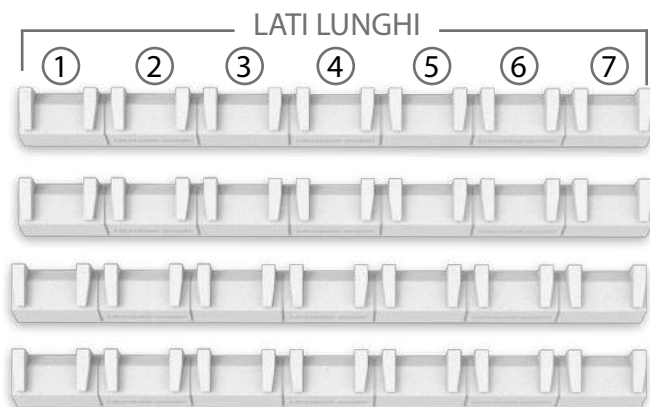

4

Galleggianti interi

Taglio dei galleggianti per Lucernario Aerante INOX su misura

Conta il numero di prese d'aria per ogni gruppo di prese d'aria

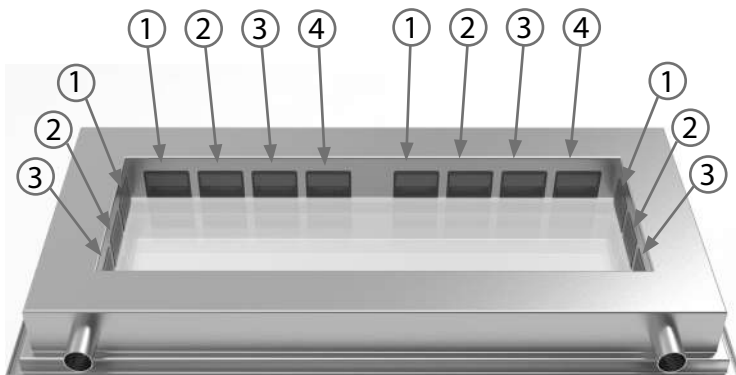

Nell'esempio qui sopra abbiamo due gruppi da 4 prese d'aria e due gruppi da 3 prese d'aria, qui sotto un esempio di taglio.

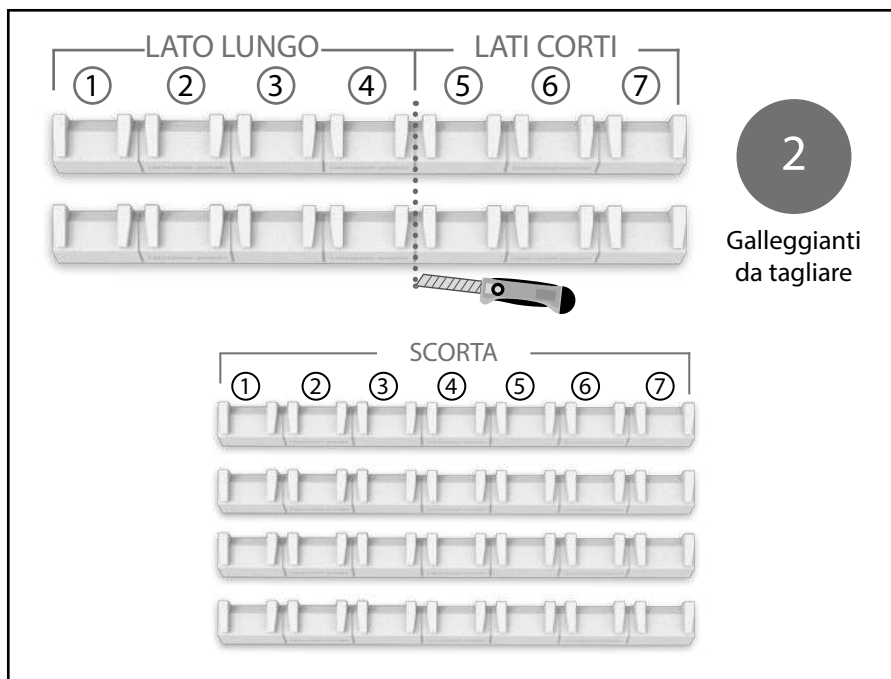

Installazione

Posizionamento dei galleggianti

Per sapere che il verso è giusto, assicurati di poter leggere il marchio Lucernario Aerante mentre inserisci il galleggiante con la parte piana rivolta verso le prese d'aria.

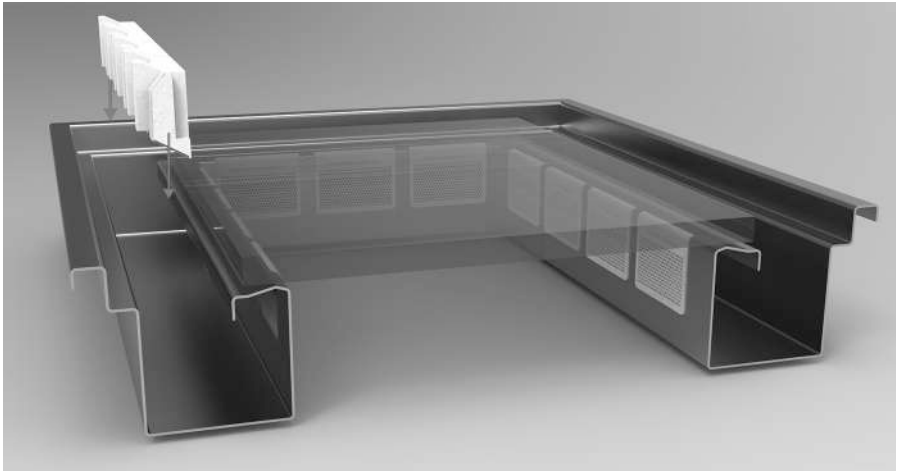

Appoggia il galleggiante alle prese d'aria.

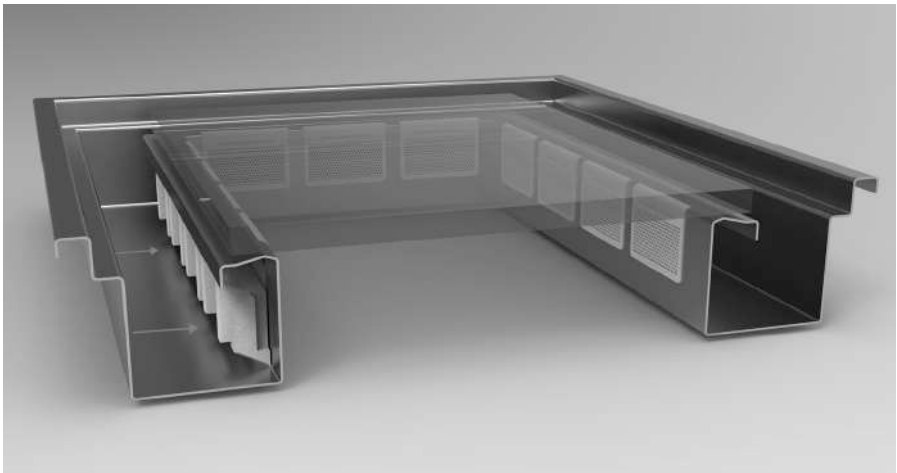

Posizionamento delle staffe-guida

Inclina le staffe-guida per inserirle all'interno del fossetto.

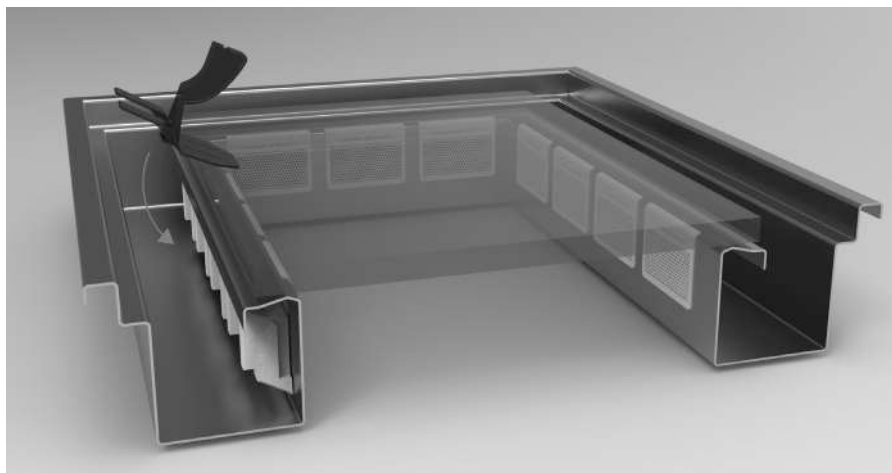

Fai corrispondere le tacche presenti sulle staffe-guida con quelle sulla struttura di Lucernario Aerante INOX.

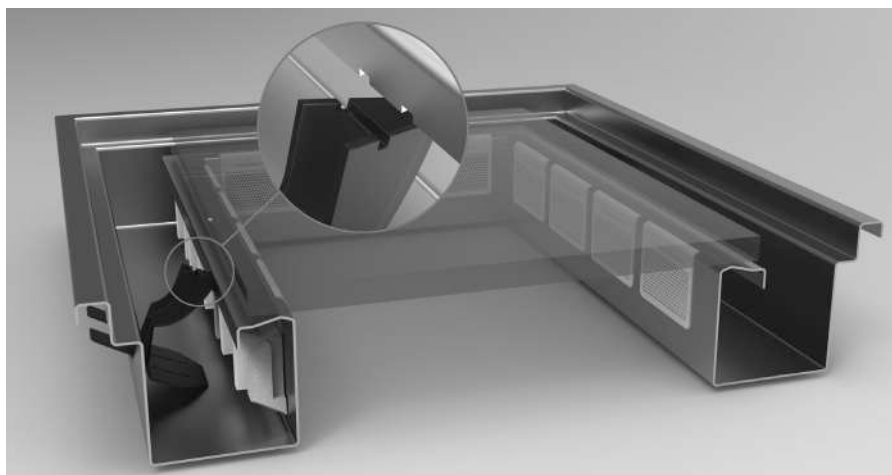

Index

pag. 25 - Important notes on Acquastop functioning

pag. 27 - Box contents

pag. 28 - Cutting the floats

pag. 29 - Model-specific guide

pag. 43 - Installation

Key points regarding the functioning of the Acquastop system

The Lucernario aerante Acquastop flood prevention system is designed against flooding within lightwells or light shafts. In the event of a drainage blockage, Acquastop activates. It functions by increasing the water level within the ventilation shaft, which triggers the movement of specialized guide brackets. These brackets lead the Acquastop device from a horizontal resting position to a vertical operating position. This action effectively seals the air passage, preventing water infiltration into the areas below.



The air vent closure is effective but not fully watertight. Leakage of droplets and small amounts of water may occur despite Acquastop being in its operational position. After each activation, Acquastop must be manually reset to its horizontal rest position.



Please notice these following warnings

The Acquastop system may not function optimally under all conditions. Regular maintenance is recommended as it is essential to prevent potential performance issues

Cleaning

Accumulation of debris such as leaves, pebbles, pine needles, and animal hair within the Lucernario aerante ventilation gutter can obstruct the Acquastop float's movement. This obstruction can hinder the proper functioning of the Acquastop flood prevention system.

Regular cleaning of debris collection channel is essential to ensure the Acquastop system operates correctly and prevent potential malfunctions.

Sticky sediments

If left in the resting position for an extended period, the Acquastop float may become stuck to the bottom of the lucernario aerante ventilation gutter due to sticky sediments. This can prevent the float from rising to its working position when required.

During period gutter cleaning, always ensure the float is free to move by gently dislodging it from its resting position

Adverse weather conditions

The Acquastop flood prevention system is designed to protect against flooding caused by adverse weather conditions. However, the potential consequences of extreme weather events are unpredictable.

During floods, storms, or inundations, the water may carry debris or mud that can obstruct the float's path, potentially rendering the system ineffective.

This is a photograph of the specialized testing bench used to evaluate the performance of the Acquastop system

Box contents

Float

6

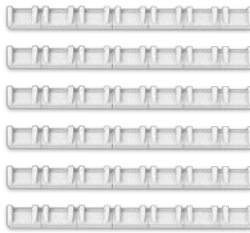

Guide bracket

12

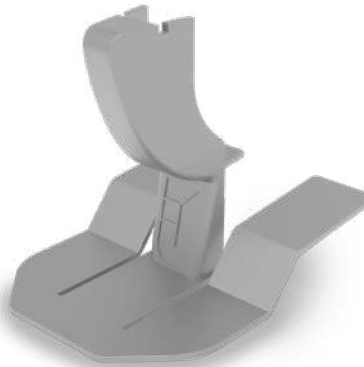

Float Cutting

Step 1 - Identify the model of your Lucernario Aerante INOX



Model	Measurement	
XS55	55	130
XS85	85	130
S65	65	150
S85	85	150
M65	65	170
L65	65	190

Model	Measurement	
XS66	66	130
XS96	96	130
S76	76	150
S96	96	150
M76	76	170
L76	76	190

Step 2 - General cutting instructions

HOW TO CUT THE FLOAT

Locate the pre-marked cutting line. Position the float on a level surface and employ a sharp blade to execute a neat and straight cut.

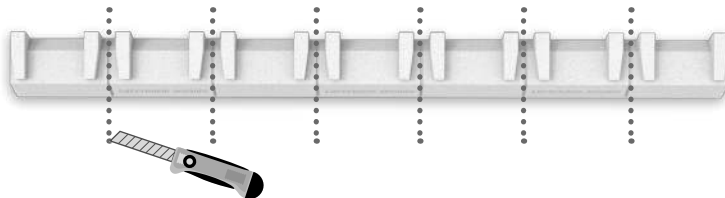

WHERE TO CUT

Consult the guidelines for your specific model

Model XS55

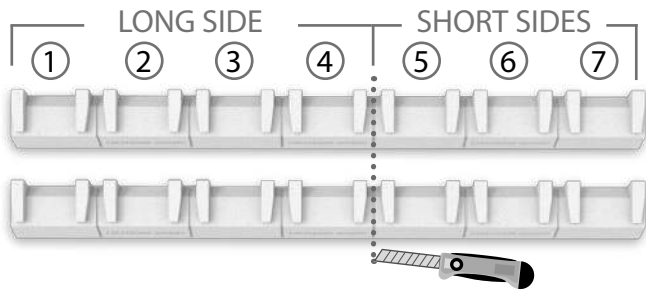

2

Floats to cut

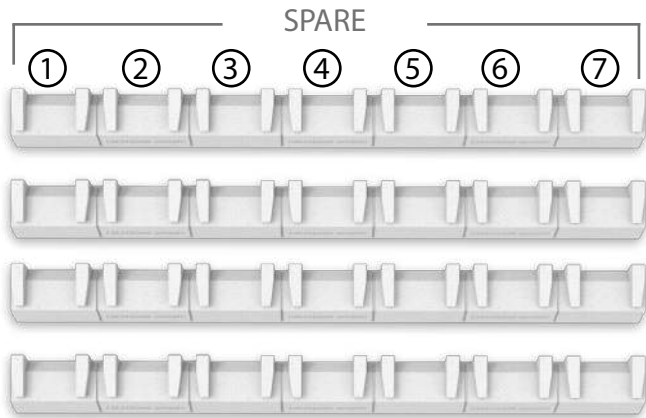

Model XS85

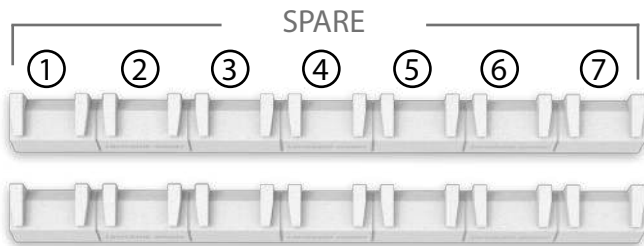
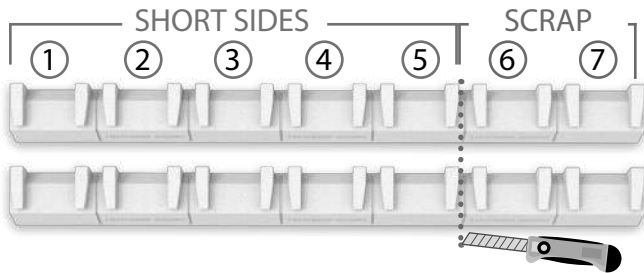
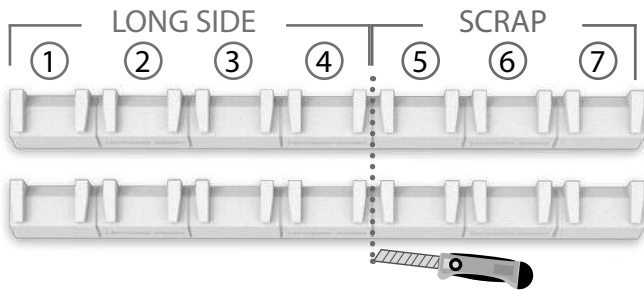

4
Floats to cut

Model S65

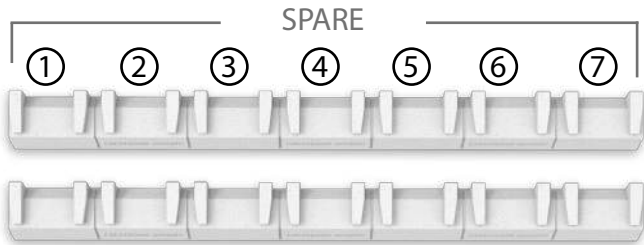
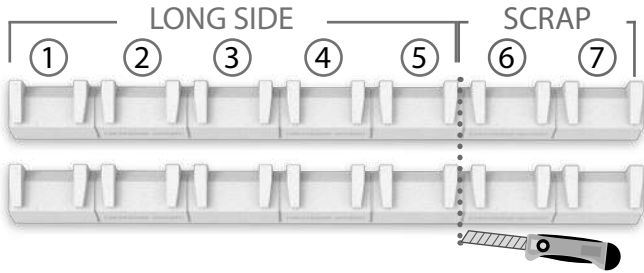
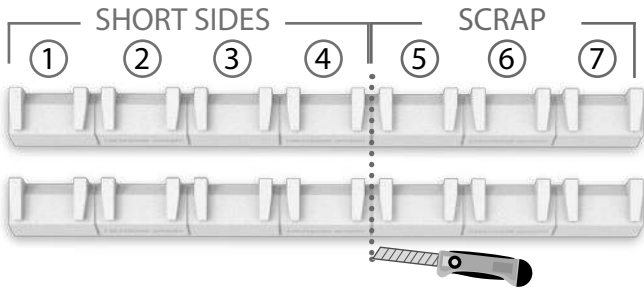

4

Floats to cut

Model S85

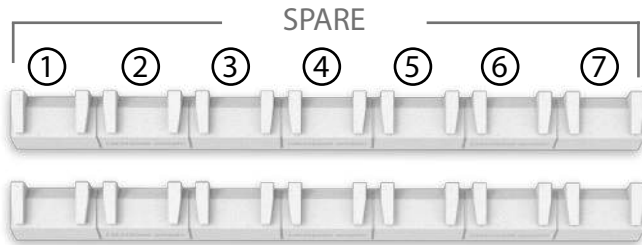
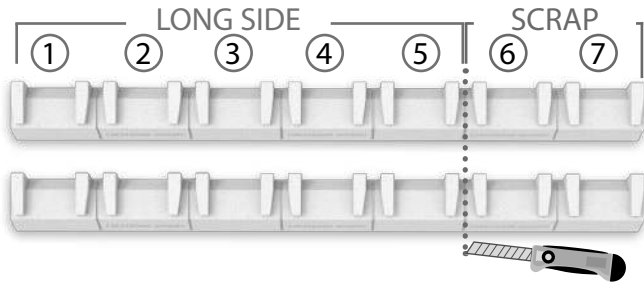
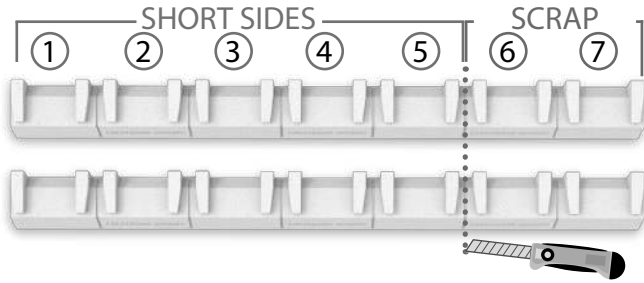

4
Floats to cut

Model M65

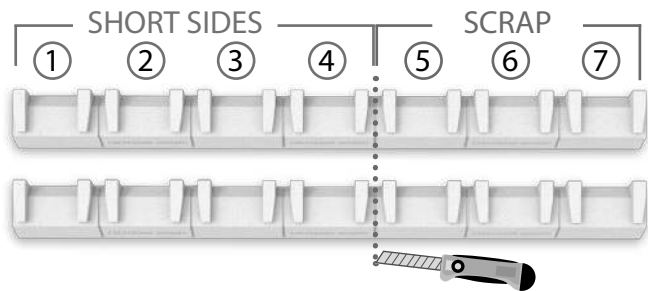

4

floats to cut

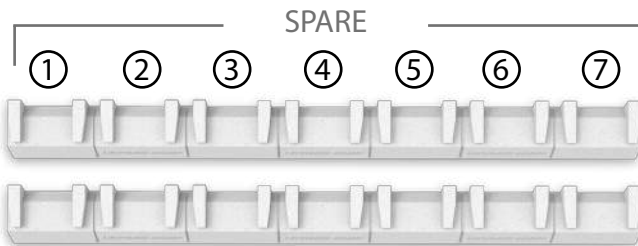
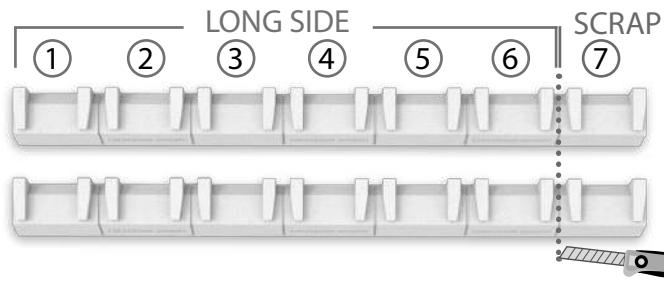

Model L65

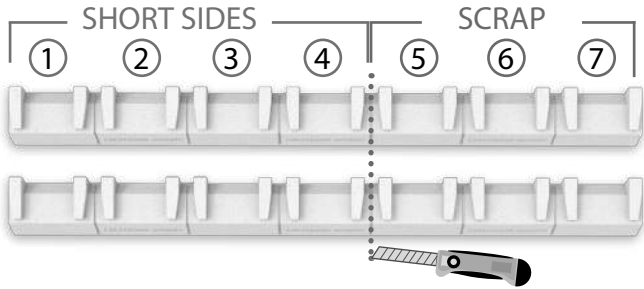

2
floats to cut

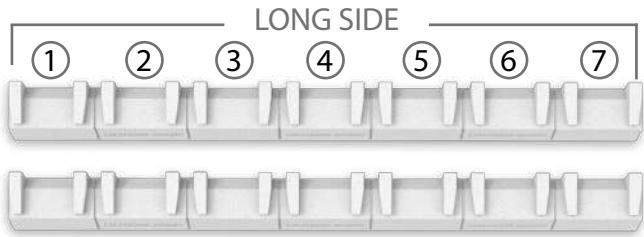

2
whole floats

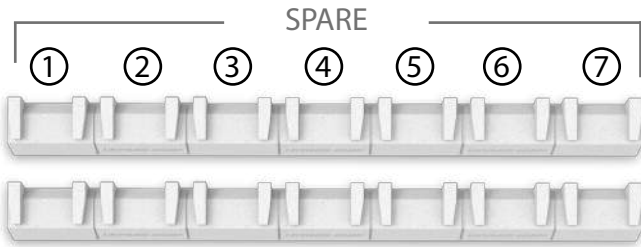

Model XS66

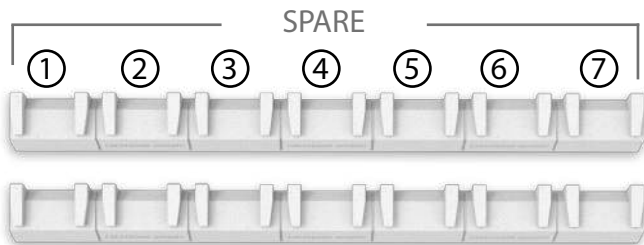
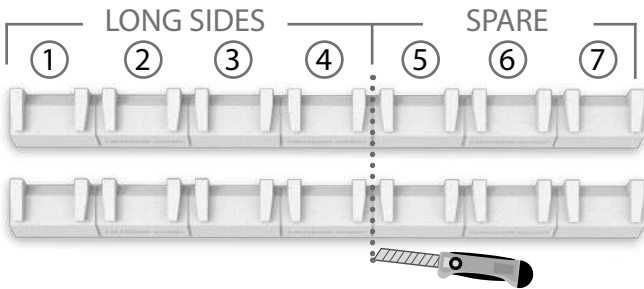
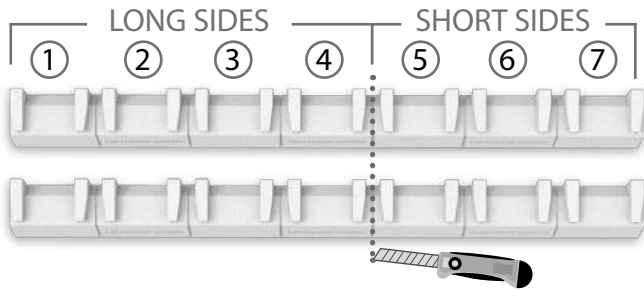

4
Floats to cut

Model XS96

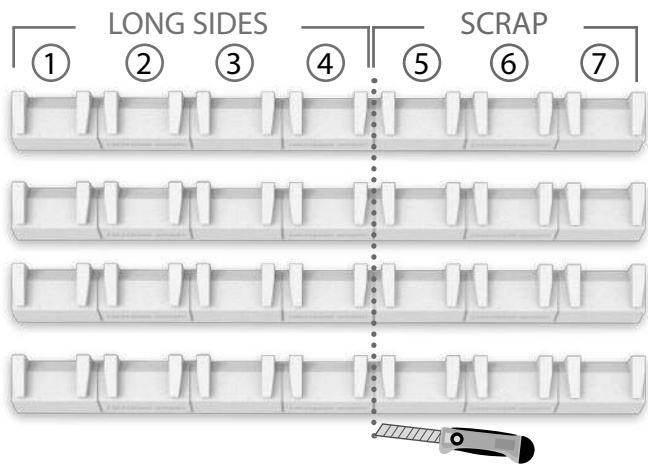

6

Floats to cut

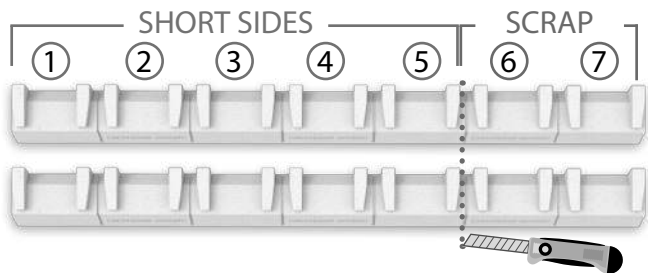

Model S76

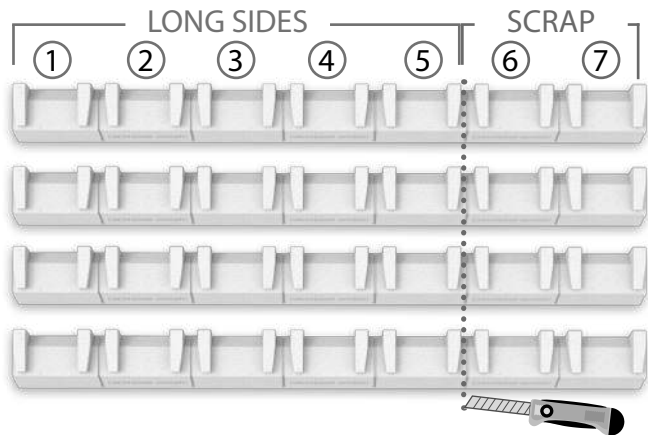
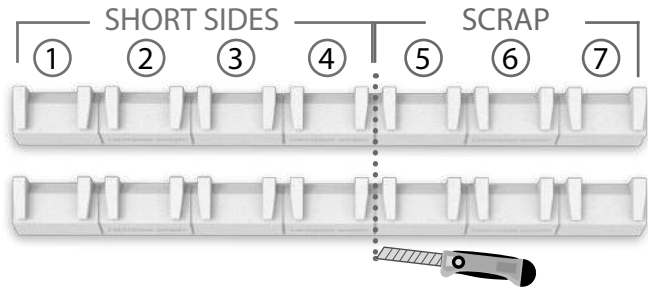

Floats to cut

Model S96

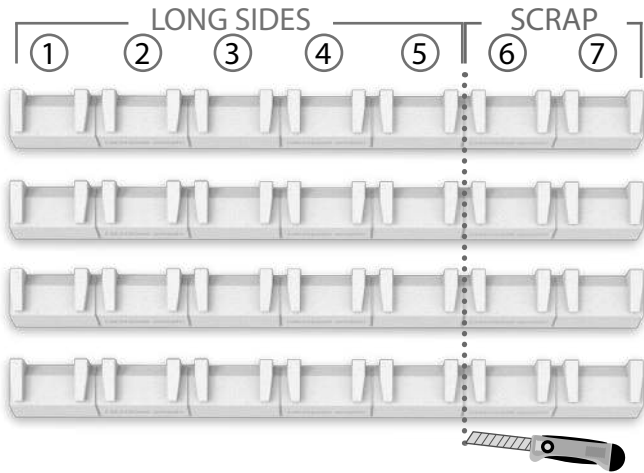
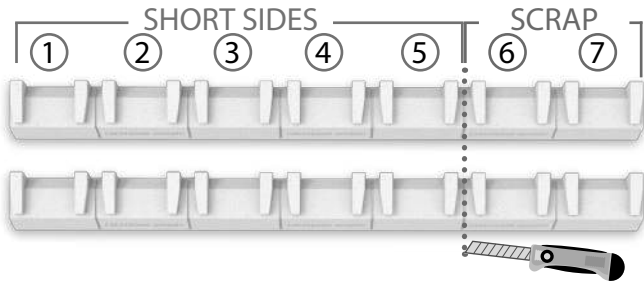

Floats to cut

Model M76

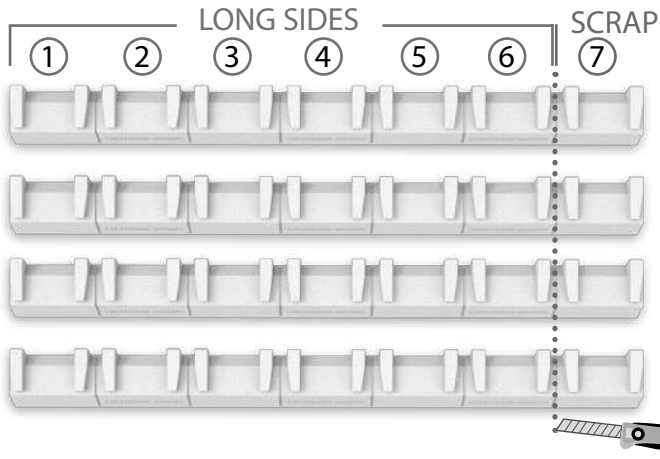
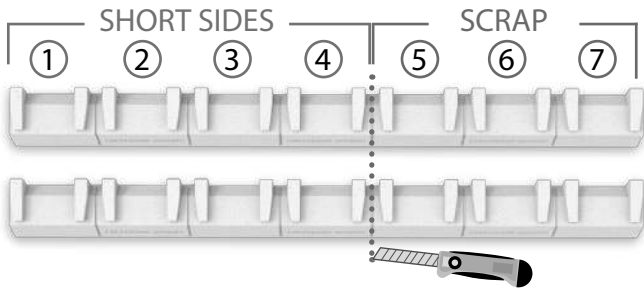

6
Floats to cut

Model L76

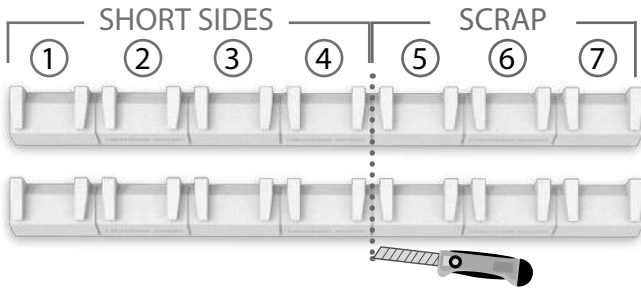

2

Floats to cut

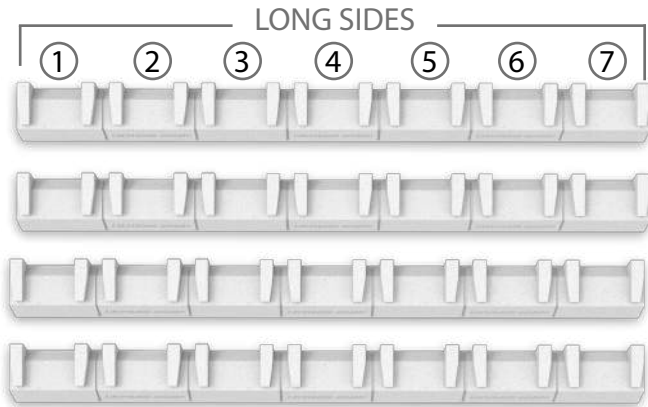

4

whole floats

Floats cutting for customized Lucernario Aerante INOX

Determine the number of air vents within each group of air vents

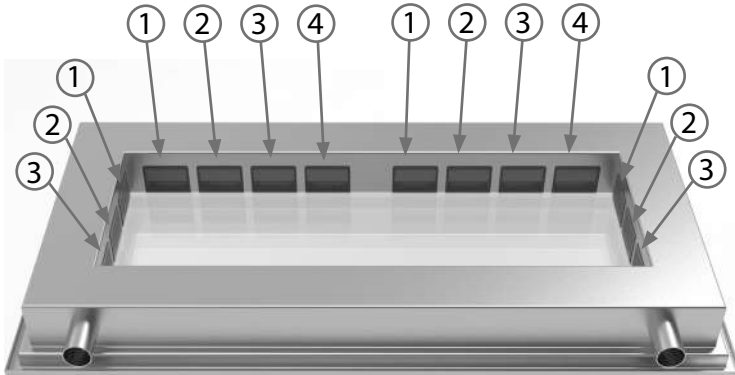

The example above shows two groups of four air vents and two groups of three air vents. Below is an example of float cutting

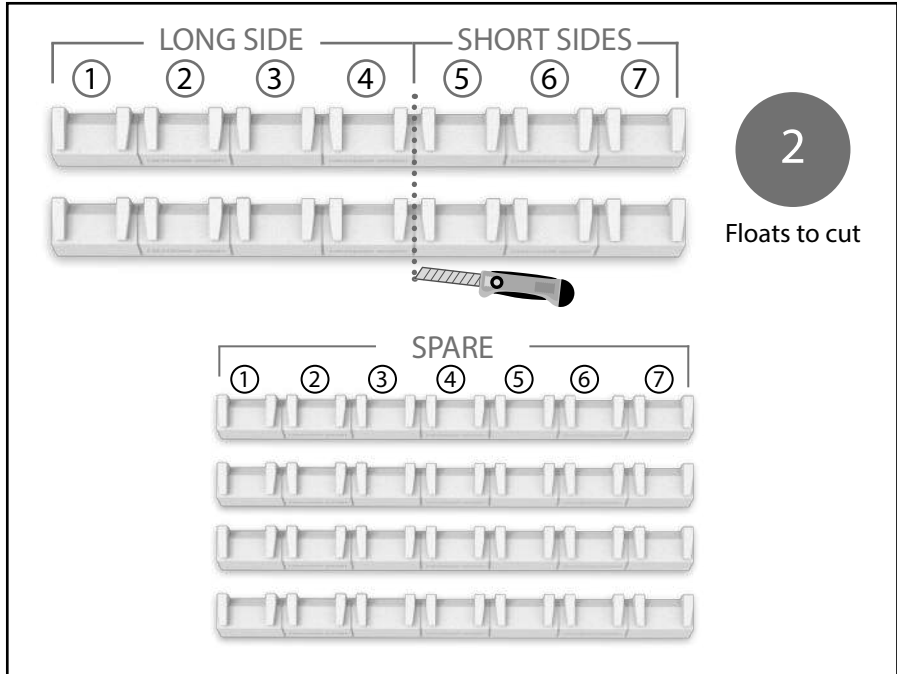

Installation

Floats placement

To verify the correct installation, check that you can read the “Lucernario aerante” brand when inserting the float with the flat side towards the vents

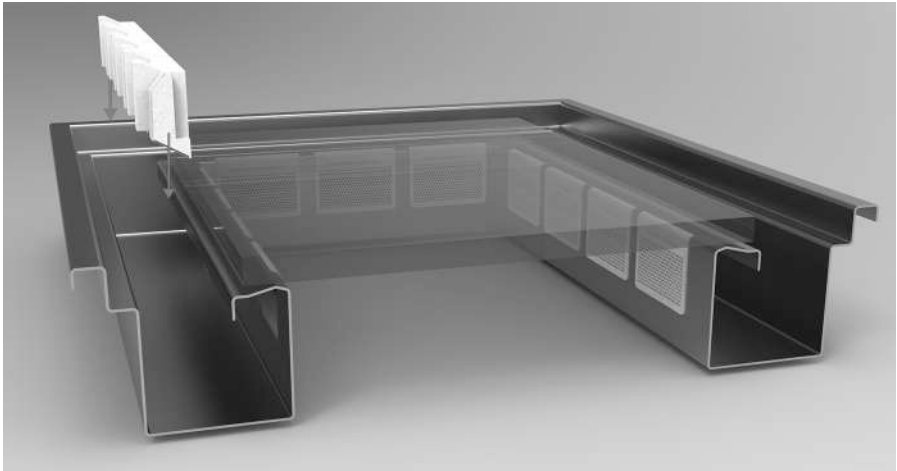

Gently rest the float against the air vents.

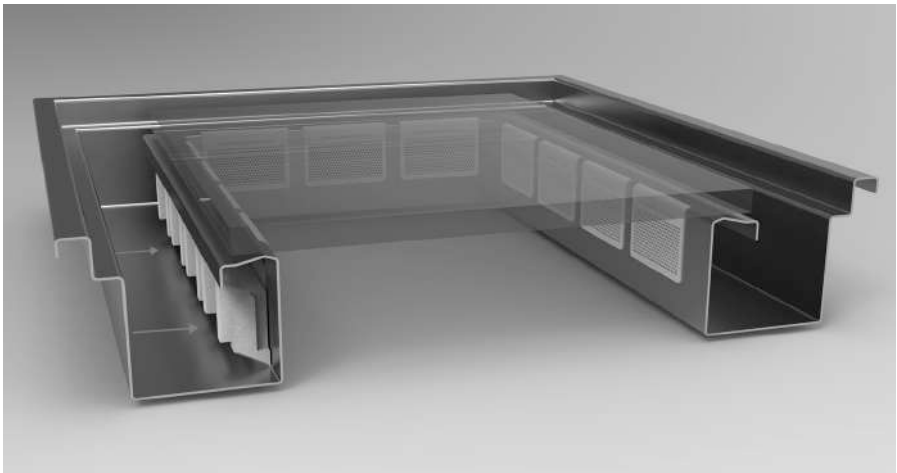

Positioning the guide brackets

Gently angle the guide brackets to slide them into the groove

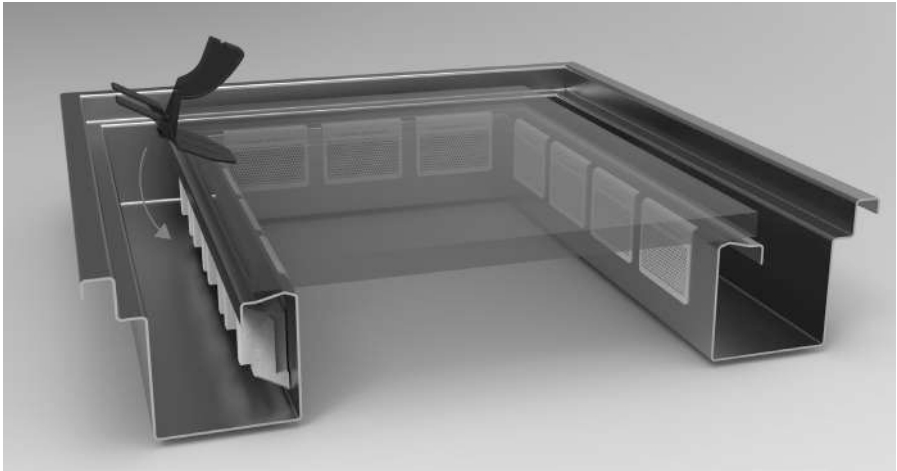

Precisely align the notches on the guide brackets with the corresponding notches on the Lucernario aerante INOX structure

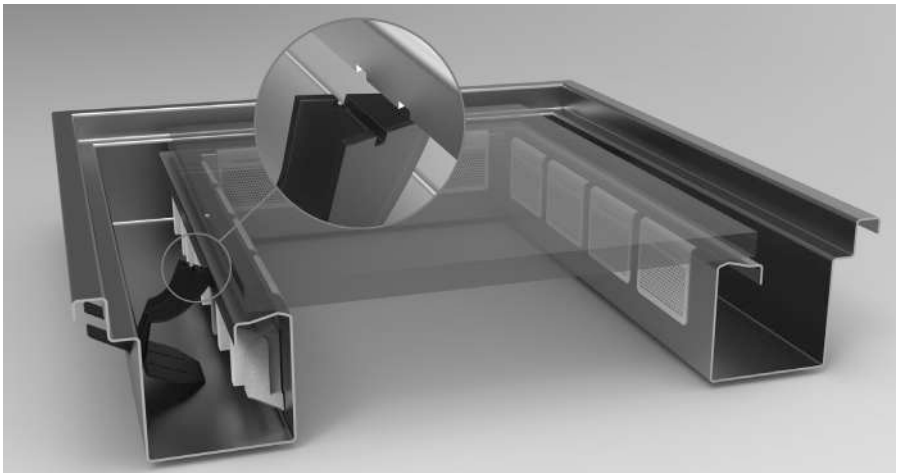

Index

Seite 47 - Wichtige Hinweise zur Funktionsweise des Aquastop-Systems

Seite 49 - Lieferumfang

Seite 50 - Zuschneiden der Schwimmer

Seite 51 - Modellbezogene Anleitungen

Seite 65 - Installation

IT

EN

DE

FR

ES

NL

GR

TR

Wichtige Hinweise zur Funktionsweise des Aquastop-Systems

Das Aquastop-system des Lucernario aerante schützt vor Überflutungen der Lichtkuppel bei einem verstopften Abfluss. Aquastop wird durch einen steigenden Wasserstand im Lüftungskanal aktiviert.

Die Führungsschienen dienen dazu, Aquastop aus der horizontalen Ruhelage in die vertikale Arbeitsposition zu bringen, um den Luftstrom zu blockieren und so das Eindringen von Wasser in die unteren Bereiche zu verhindern.



Die Abdichtung der Lüftungsöffnungen ist zwar gut, aber nicht absolut dicht. Es kann vorkommen, dass Tropfen oder kleine Wasserstrahlen auch bei aktiviertem Aquastop eindringen. Nach jedem Ereignis muss Aquastop manuell in die horizontale Ausgangsposition zurückgestellt werden.



Mögliche Störungen

Das Aquastop-System zur Überschwemmungsvermeidung ist nicht unfehlbar. Bestimmte Bedingungen können die Funktion des Systems beeinträchtigen. Diese können jedoch durch regelmäßige Wartung verhindert werden.

Reinigung

Ablagerungen wie Blätter, Steine, Kiefernadeln oder Tierhaare im Lüftungskanal des Lucernario aerante können die Bewegung des Aquastop-Schwimmers behindern. Eine regelmäßige Reinigung des Schmutzauffangkanals ist daher unerlässlich, um Störungen des Aquastop-Systems zu vermeiden.

Klebrige Ablagerungen, die den Schwimmer festhalten

Bleibt der Aquastop-Schwimmer längere Zeit in Ruheposition, kann er am Boden des Lüftungskanals des Lucernario aerante festkleben und sich bei Bedarf nicht in die Arbeitsposition bewegen.

Bei der regelmäßigen Reinigung des Lüftungskanals sollte der Schwimmer daher bewegt werden, um sicherzustellen, dass er frei beweglich ist.

Ungünstige Wetterbedingungen

Das Aquastop-System zum Schutz vor Überschwemmungen wurde entwickelt, um Schäden durch extreme Wetterbedingungen zu verhindern. Die möglichen Folgen von extremen Wetterereignissen sind jedoch unvorhersehbar.

Während einer Überschwemmung, eines Sturms oder einer Überflutung können durch das Wasser mitgeführte Ablagerungen oder Schlamm den Weg des Schwimmers blockieren und so die Funktionsfähigkeit des Systems beeinträchtigen.

Abbildung: Der Prüfstand zeigt, wie das Aquastop-System unter verschiedenen Bedingungen getestet wird.

Lieferumfang

Schwimmer

6

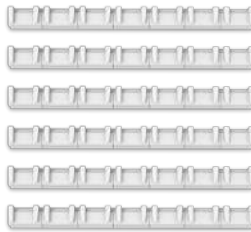

Führungsbügel

12

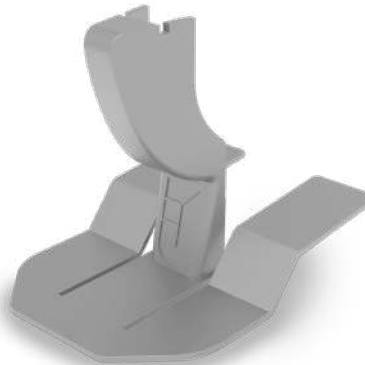

Zuschneiden der Schwimmer

Schritt 1 - Bestimmen Sie die genaue Modellbezeichnung Ihres Lucernario Aerante INOX



Modell	Abmessung	
XS55	55	130
XS85	85	130
S65	65	150
S85	85	150
M65	65	170
L65	65	190

Modell	Abmessung	
XS66	66	130
XS96	96	130
S76	76	150
S96	96	150
M76	76	170
L76	76	190

Schritt 2 - Allgemeine Schnitthanweisungen

SO SCHNEIDEN SIE

Markieren Sie die genaue Schnittlinie auf dem Schwimmer

Verwenden Sie ein scharfes Messer und eine stabile Unterlage, um einen sauberen und geraden Schnitt zu gewährleisten

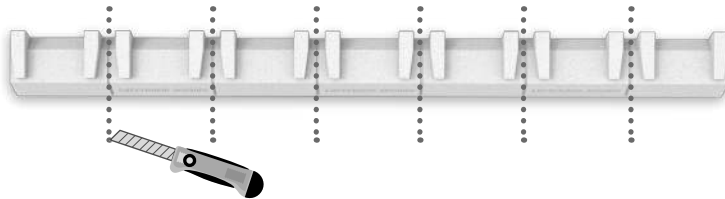

Schnittstelle bestimmen

Die genaue Schnittstelle ist in den modellbezogenen Anleitungen angegeben.

Modell XS55

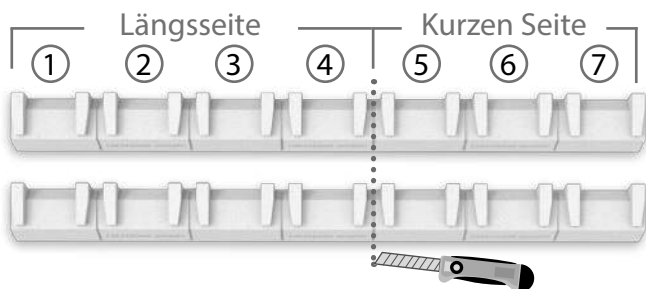

Schwimmer zum
Zuschneiden

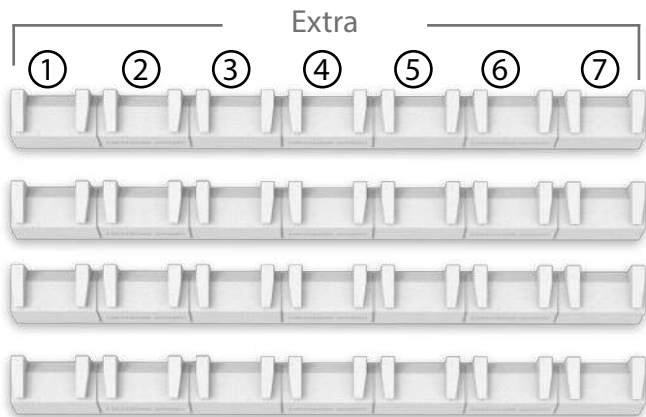

Modell XS85

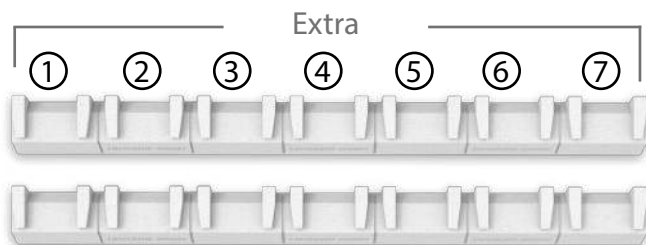
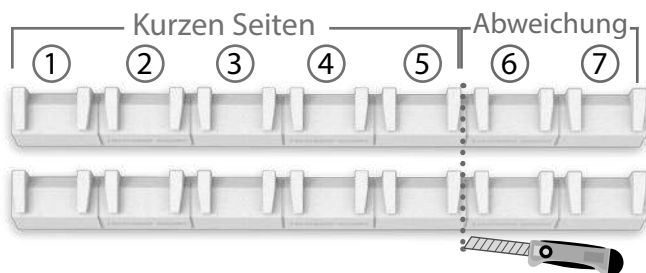
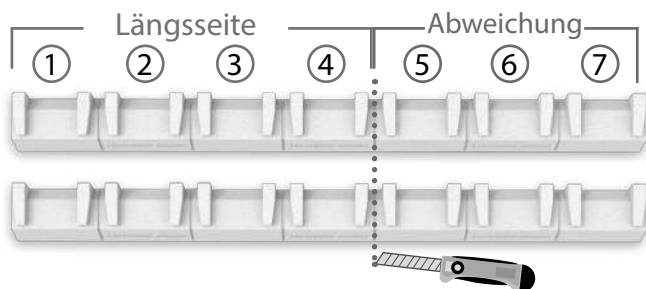

4

Schwimmer zum
zuschneiden

Modell S65

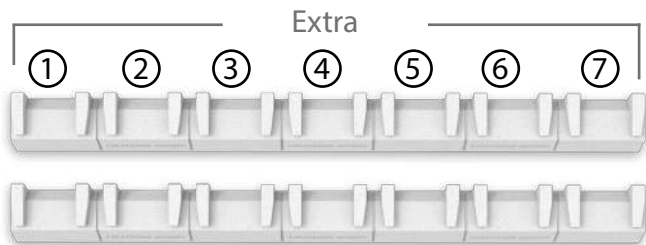
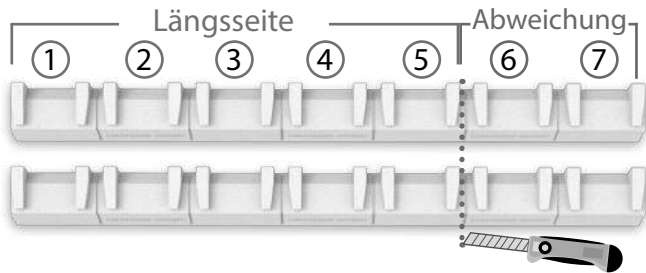
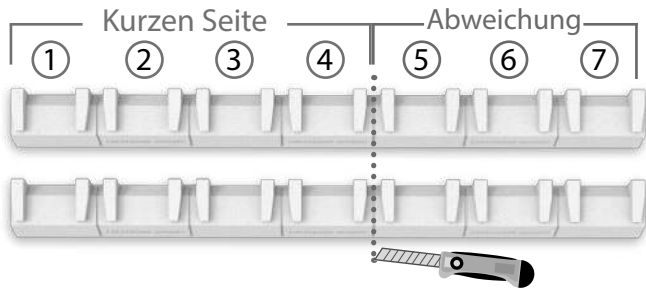

4

Schwimmer zum Zuschneiden

Modell S85

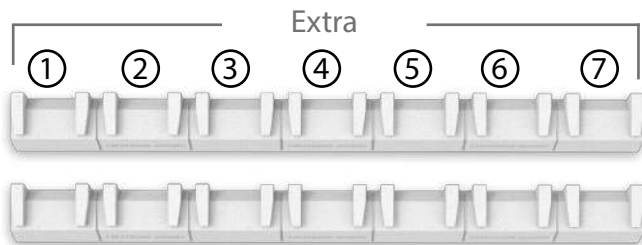
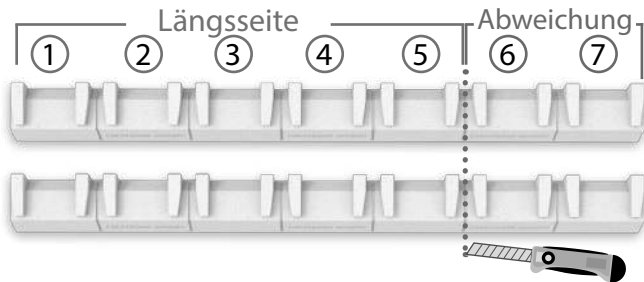
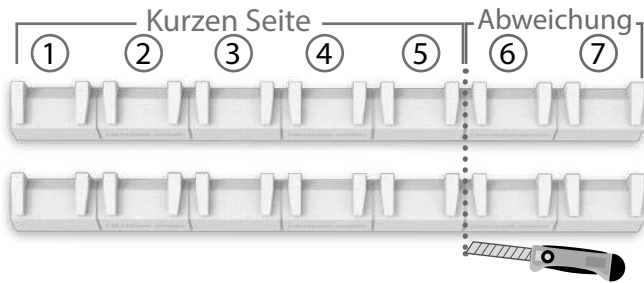

4

Schwimmer zum
zuschneiden

Modell M65

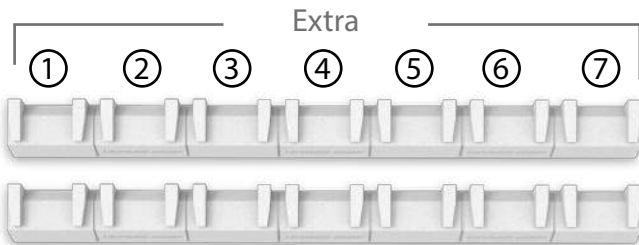
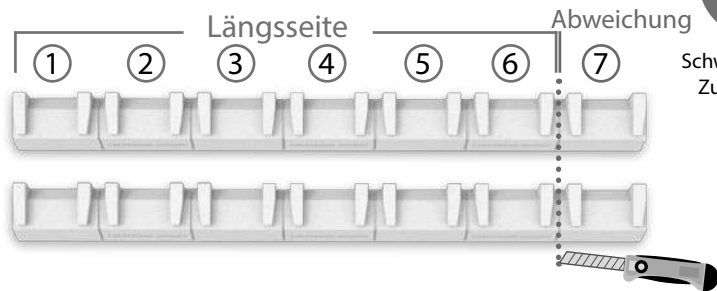
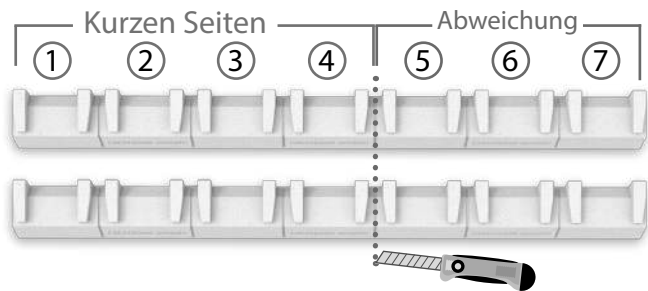

4

Schwimmer zum Zuschneiden

Modell L65

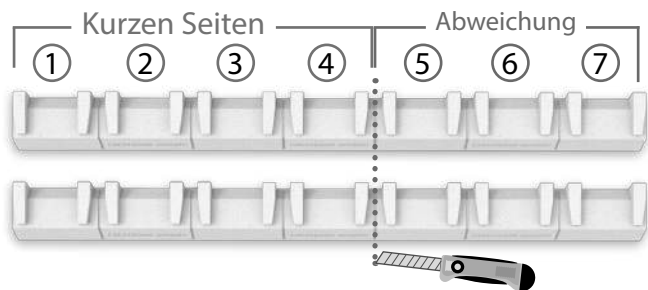

2

Schwimmer zum
Zuschneiden

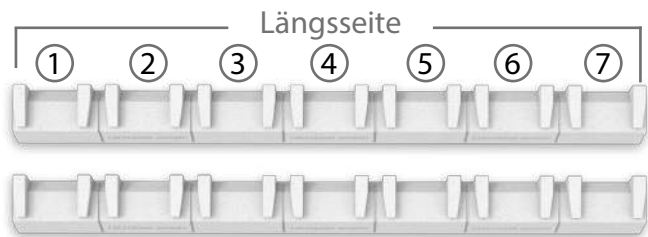

2

Ungekürzte
Schwimmer

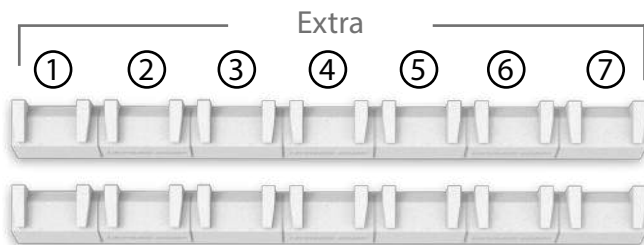

Modell XS66

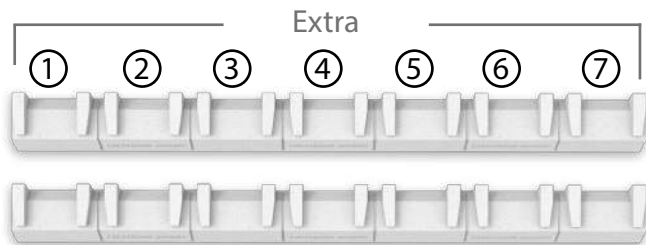
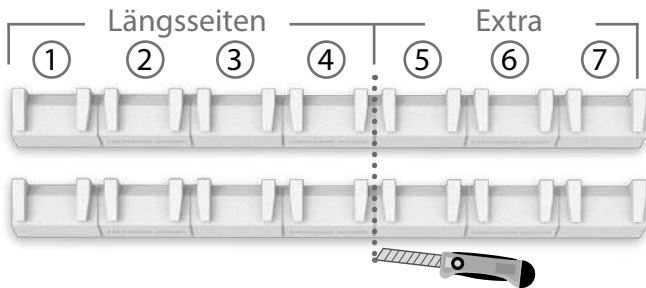
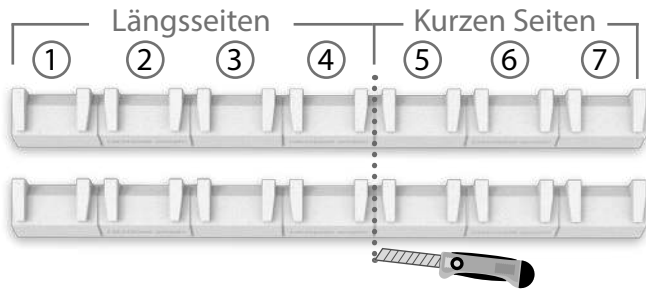

4

Schwimmer zum
Zuschneiden

Modell XS96

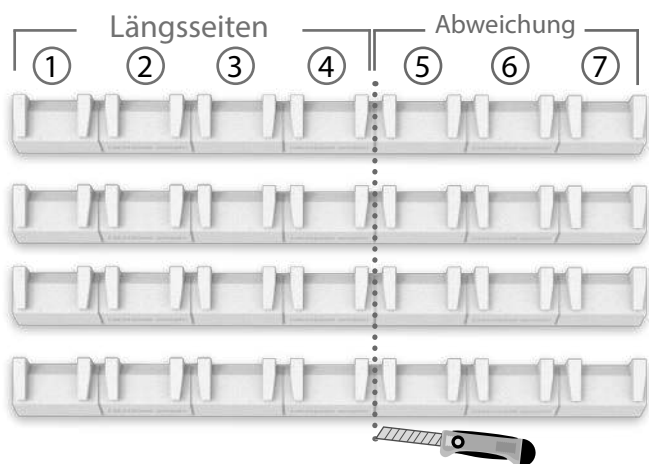

6

Schwimmer zum Zuschneiden

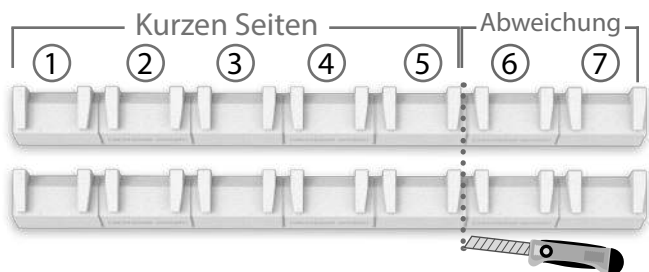

Modell S76

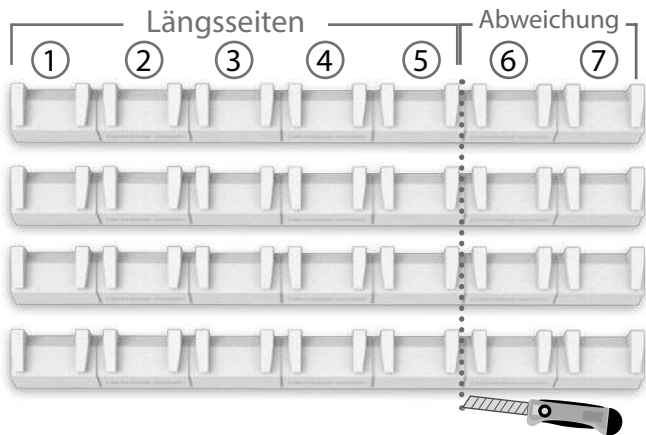
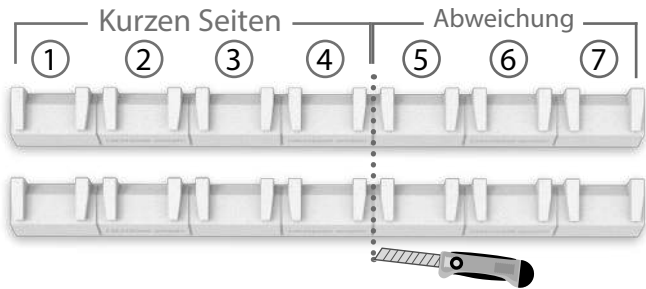

Schwimmer zum
Zuschneiden

Modell S96

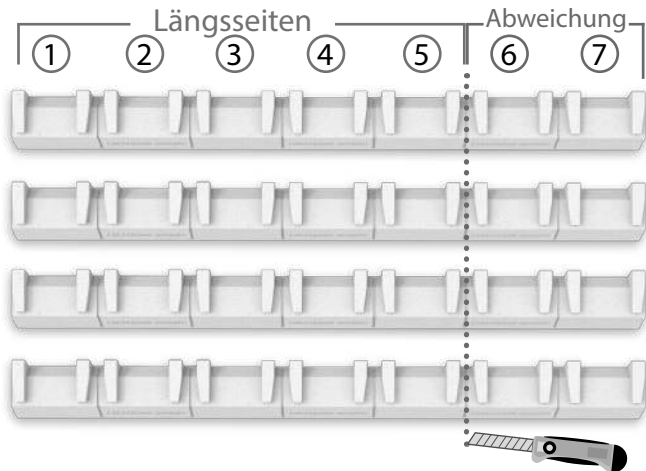
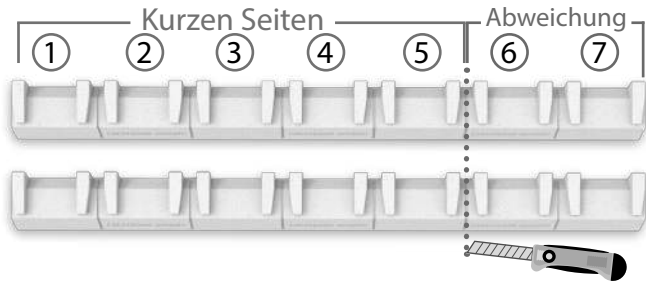

Schwimmer zum
Zuschneiden

Modell M76

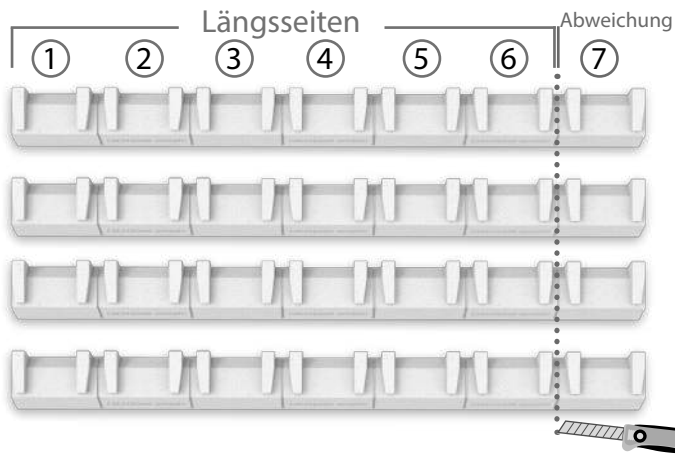
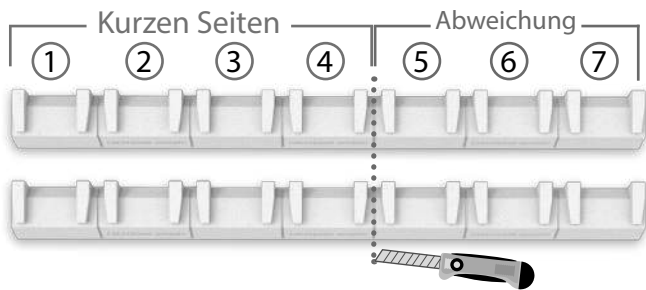

6

Schwimmer zum
Zuschneiden

Modell L76

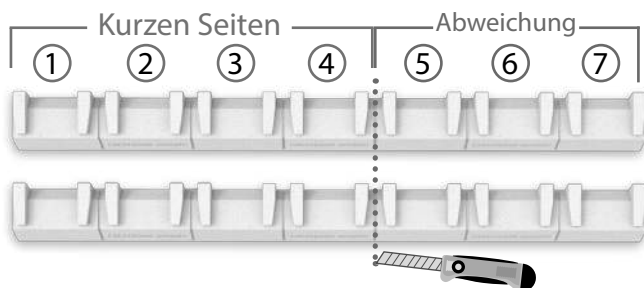

2

Schwimmer zum Zuschneiden

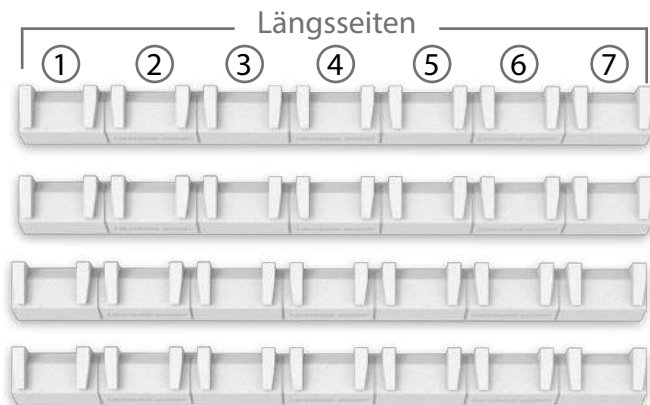

4

Ungekürzte Schwimmer

Zuschneiden der Schwimmer für Maßgefertigte Lucernario Aerante Inox

Zählen Sie die Anzahl der Lüftungsschlitze pro Gruppe

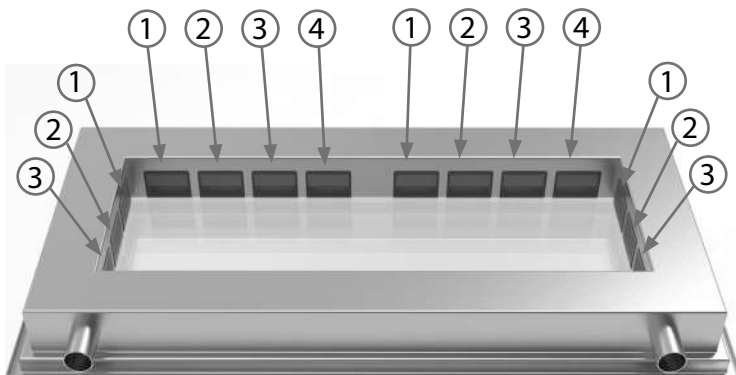

Das Beispiel zeigt zwei Gruppen mit jeweils vier Lüftungsschlitze und zwei Gruppen mit jeweils drei Lüftungsschlitze

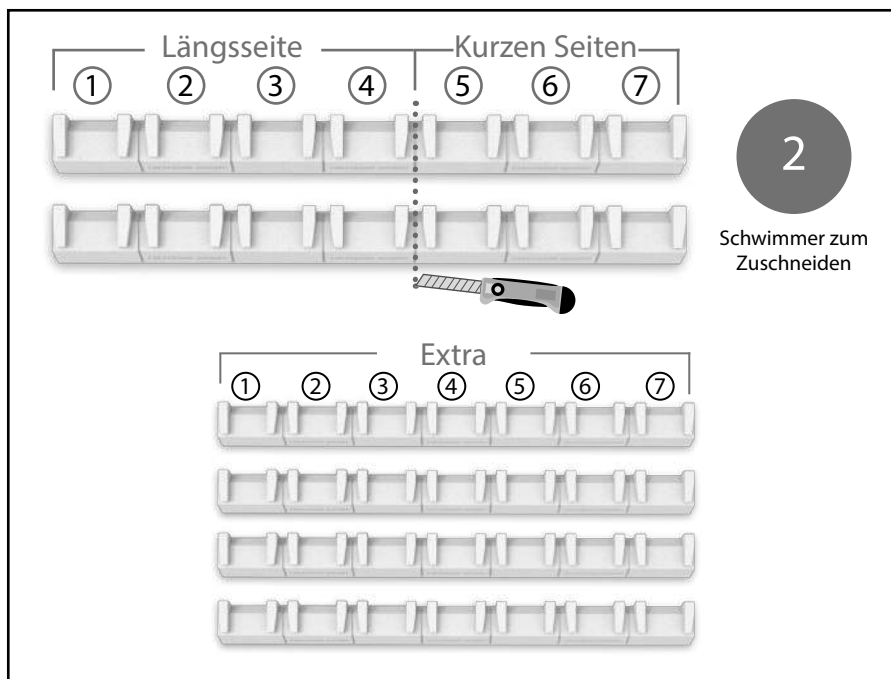

Installation

Platzierung der Schwimmer

Um die richtige Einbaurichtung zu gewährleisten, achten Sie darauf, dass Sie die Aufschrift „Lucernario aerante“ lesen können, während Sie den Schwimmer mit der flachen Seite zur Lüftungsöffnung hin einsetzen.

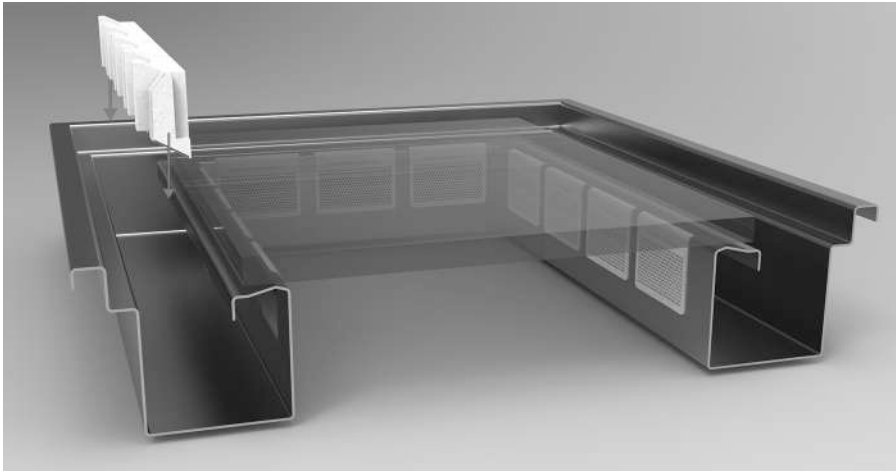

Legen Sie den Schwimmer an die Lüftungsöffnungen an.

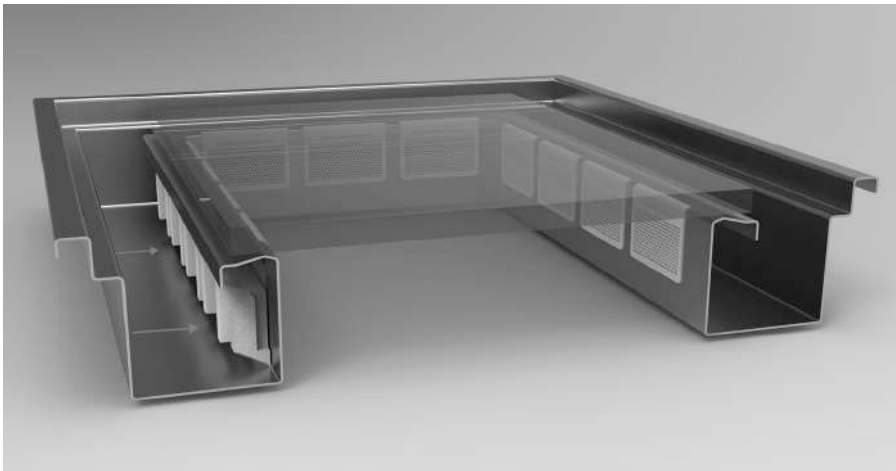

Platzierung der Führungsbügel

Neigen Sie die Führungsbügel, um sie in den Schlitz einzuführen.

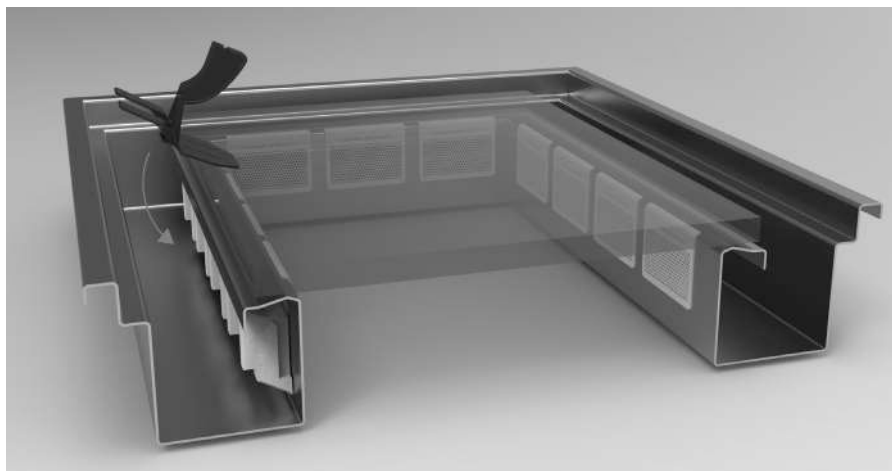

Achten Sie darauf, dass die Markierungen an den Führungsbügel mit denen am Lucernario aerante Inox übereinstimmen.

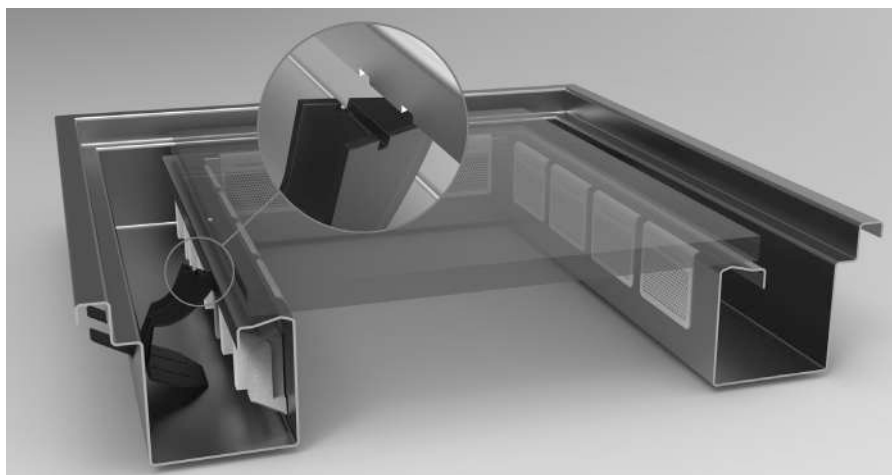

Sommaire

Page 69 - Informations importantes sur le système Aquastop

Page 71 - Contenu de l'emballage

Page 72 - Découpe des flotteurs

Page 73 - Guide d'installation détaillé par modèle

Page 87 - Procédure d'installation

IT

EN

DE

FR

ES

NL

GR

TR

Informations importantes concernant le fonctionnement du système Aquastop

Le système de prévention des inondations Aquastop de Lucernario aerante est conçu pour protéger contre les inondations du puits de lumière en cas de blocage de l'évacuation. Aquastop fonctionne en augmentant le niveau d'eau dans le conduit de ventilation. Les guides dirigent Aquastop de sa position horizontale de repos vers sa position de travail verticale, ce qui bloque l'aération et empêche l'infiltration d'eau dans les espaces situés en dessous.



Il est important de noter que même si Aquastop est très efficace, il ne peut garantir une étanchéité parfaite, dans toutes les conditions. Des gouttes ou de petits jets d'eau peuvent traverser l'étanchéité, même lorsque Aquastop est en position de travail.

Après chaque utilisation, il est nécessaire de remettre manuellement Aquastop en position horizontale de repos pour le préparer à une prochaine utilisation.



Risques de dysfonctionnement

Le système Aquastop, bien qu'efficace, peut être soumis à des dysfonctionnements. Des conditions spécifiques peuvent altérer son fonctionnement optimal. Un entretien régulier est essentiel pour prévenir ces dysfonctionnements et garantir la longévité du système.

Nettoyage

Pour assurer le bon fonctionnement à long terme du système Aquastop, il est essentiel de nettoyer régulièrement le conduit de ventilation.

Des débris tels que des feuilles, des petits graviers ou des poils d'animaux peuvent s'accumuler et bloquer le mouvement du flotteur.

Un nettoyage régulier permet d'éliminer ces obstructions et de garantir ainsi une protection optimale contre les inondations.

Risque d'encrassement du flotteur

Pour garantir le bon fonctionnement du système Aquastop, il est essentiel de vérifier régulièrement l'état du flotteur et de nettoyer le conduit de ventilation.

Des dépôts de substances collantes peuvent se former sur le fond du conduit de ventilation et entraîner l'adhérence du flotteur Aquastop. Il est important de vérifier régulièrement le libre mouvement du flotteur, notamment lors du nettoyage du conduit, afin de prévenir tout dysfonctionnement du système.

Conditions météorologiques extrêmes

Le système de prévention des inondations Aquastop est conçu pour faire face à la plupart des situations d'inondation liées à des conditions météorologiques défavorables. Cependant, il est important de noter que les événements météorologiques extrêmes peuvent entraîner des conséquences imprévisibles. Des débris tels que des branches, des feuilles ou des sédiments peuvent être transportés par les eaux, bloquer le flotteur et ainsi rendre le système inopérant.

La photo ci-jointe montre le banc d'essai d'Aquastop

Contenu de l'emballage

Flotteur

6

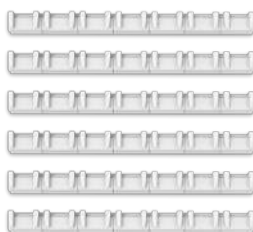

Supports-guides

12

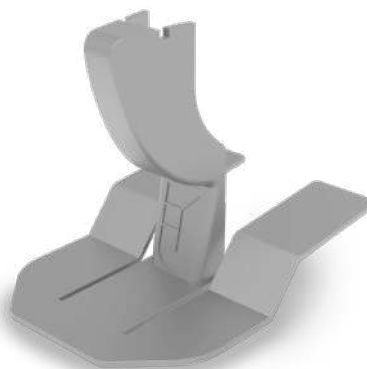

Coupe des flotteurs

Étape 1 : Identification de votre modèle de Lucernario aerante Inox



Modèle	Tailles	
XS55	55	130
XS85	85	130
S65	65	150
S85	85	150
M65	65	170
L65	65	190

Modèle	Tailles	
XS66	66	130
XS96	96	130
S76	76	150
S96	96	150
M76	76	170
L76	76	190

Étape 2 : Instructions générales de coupe

Comment couper

Localiser la ligne de coupe: repérez la ligne indiquant où couper le flotteur
Effectuer la coupe: posez le flotteur sur une surface plane et utiliser une lame tranchante pour effectuer une nette et droite.

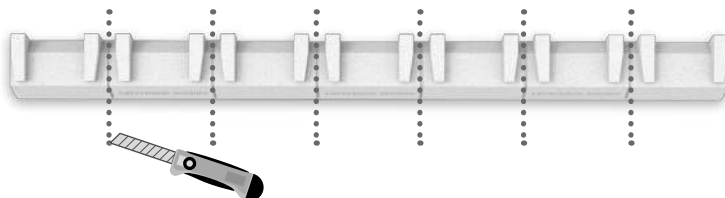

Où couper

Suivre les instructions spécifiques à votre modèle

Modèle XS55

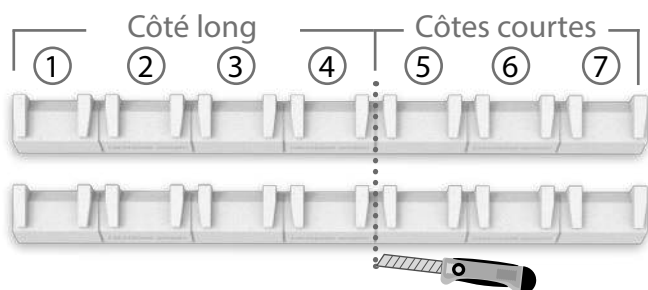

2

Flotteurs à découper

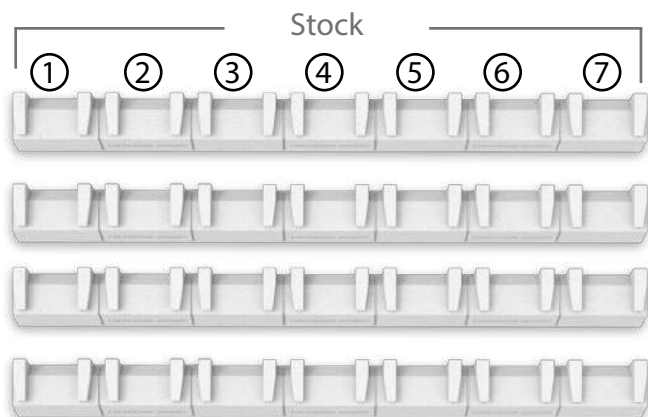

Modèle XS85

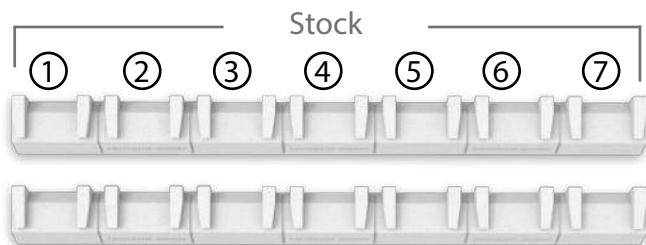
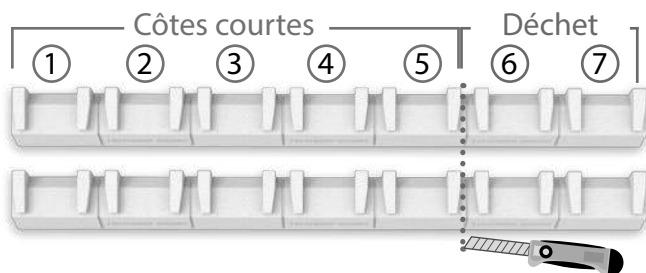
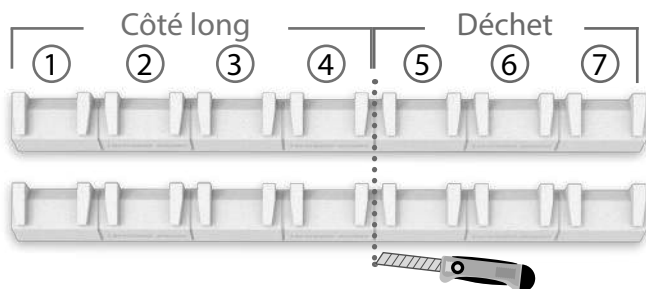

4

Floteurs à découper

Modèle S65

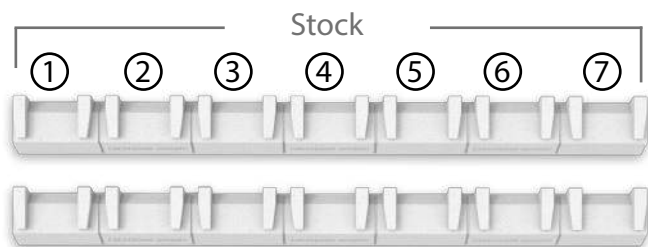
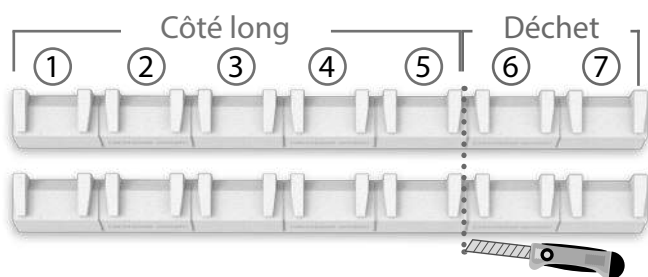
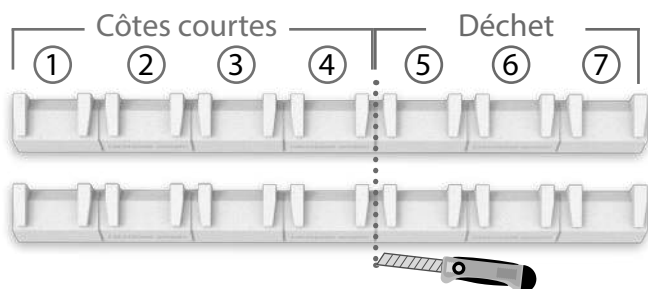

4

Floteurs à découper

Modèle S85

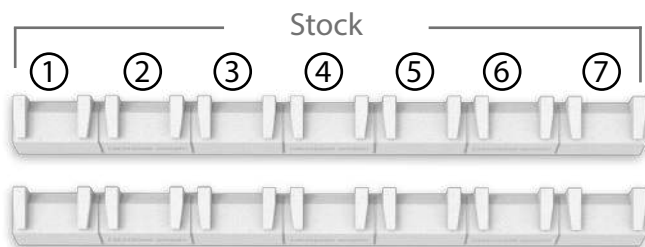
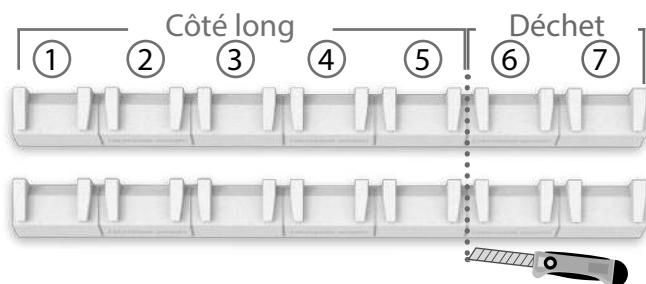
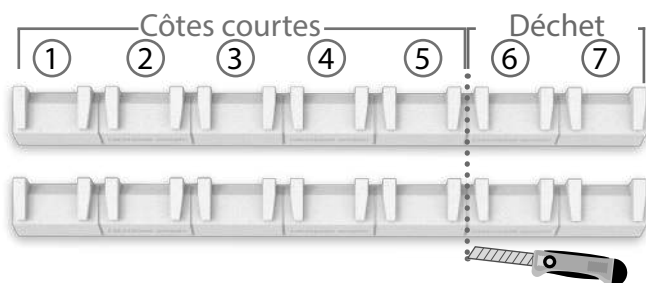

4

Flotteurs à découper

Modèle M65

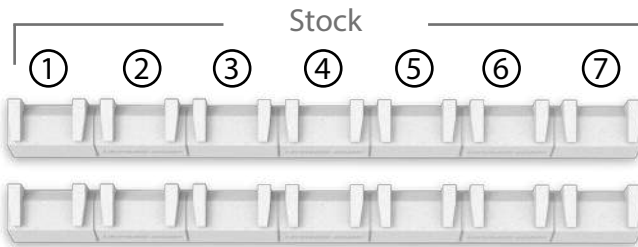
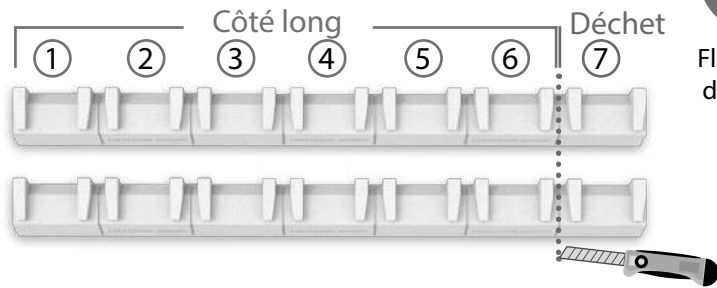
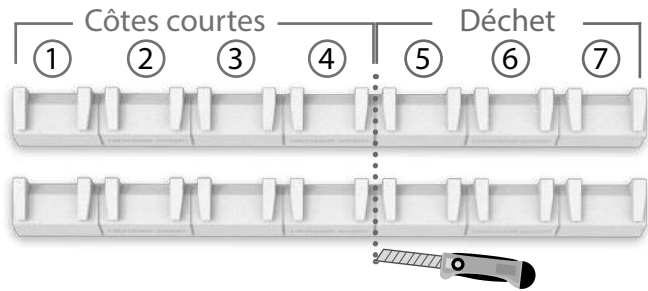

4

Floteurs à découper

Modèle L65

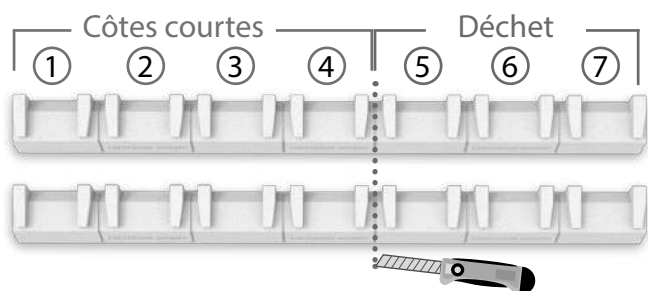

2

Flotteurs à découper

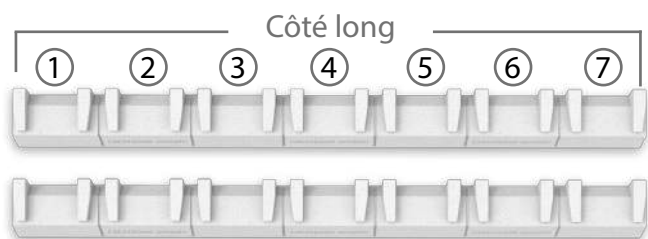

2

Flotteurs entiers

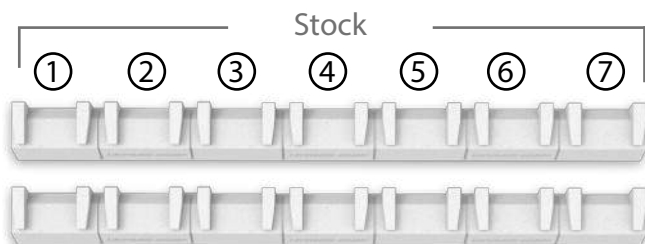

Modèle XS66

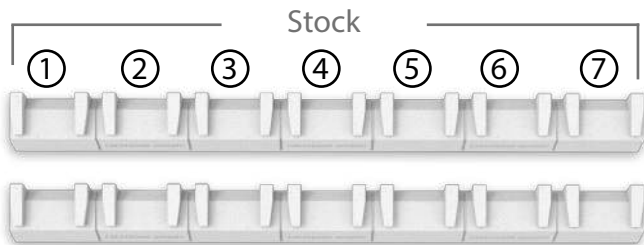
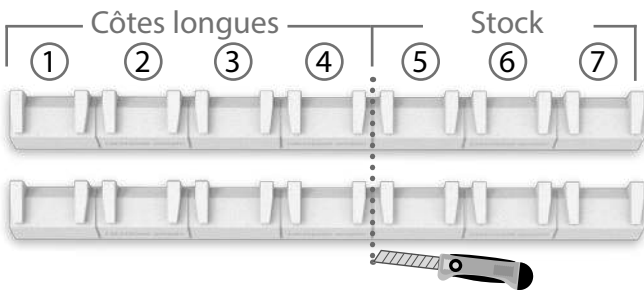
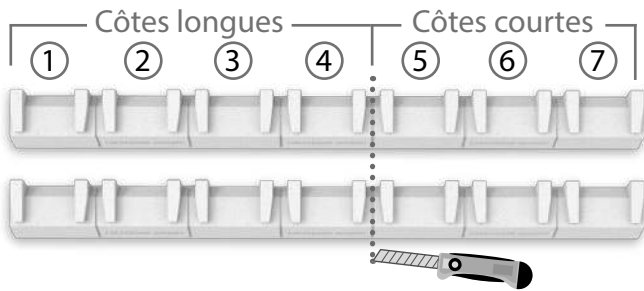

4

Flotteurs à découper

Modèle XS96

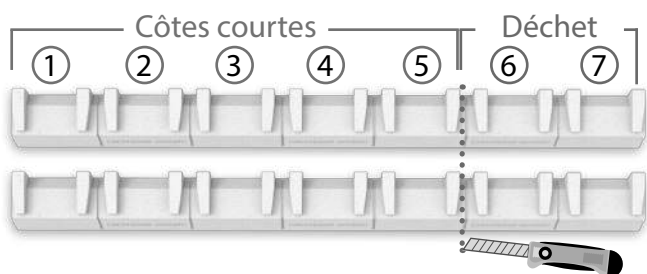
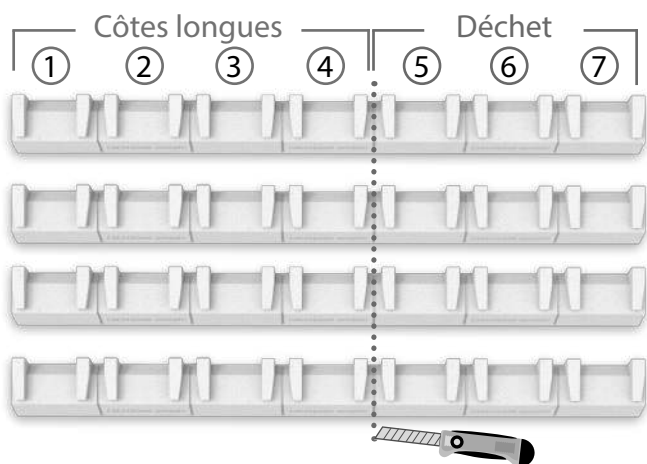

6

Floteurs à découper

Modèle S76

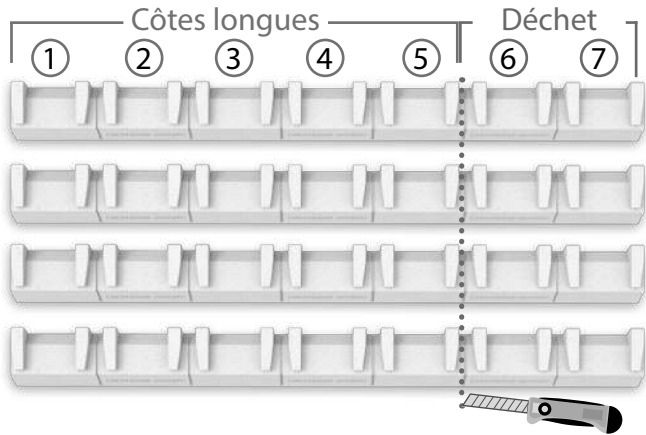
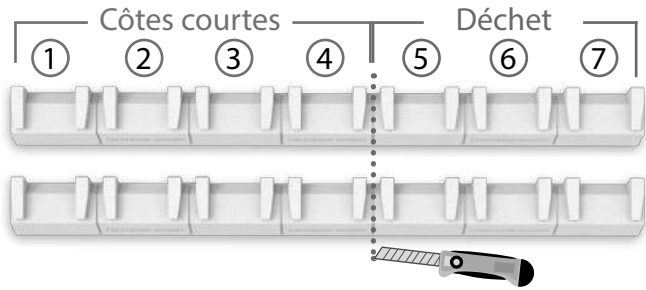

6

Flotteurs à découper

Modèle S96

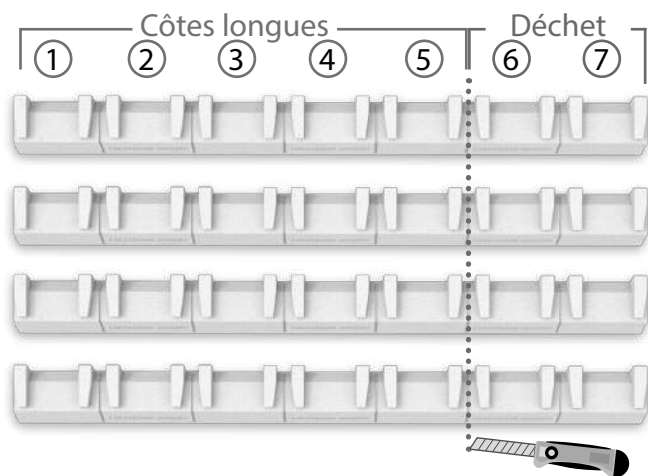
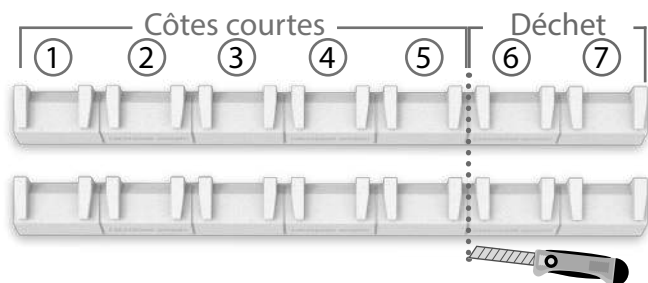

6

Floteurs à découper

Modèle M76

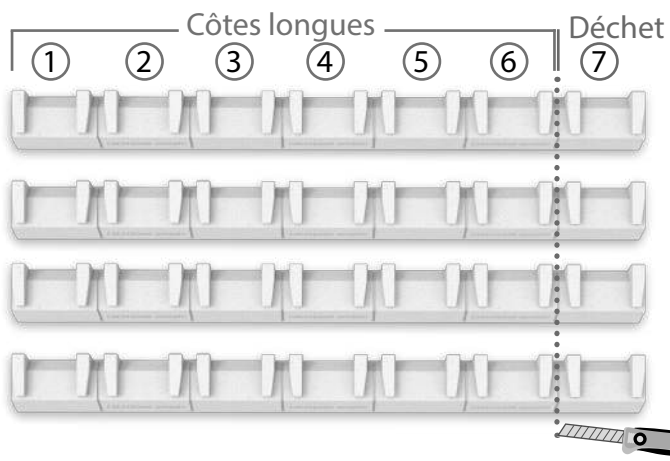
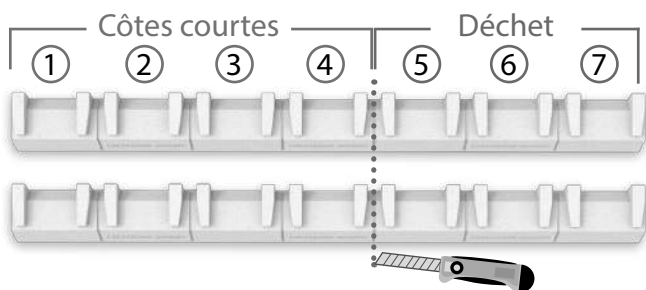

6

Flotteurs à découper

Modèle L76

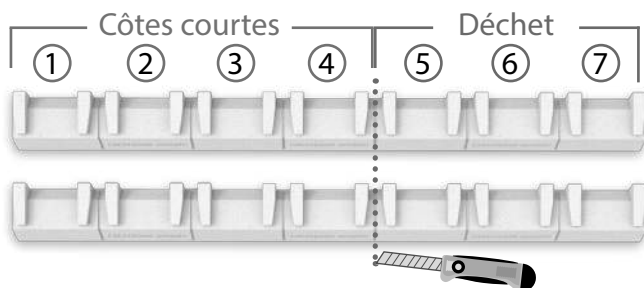

2

Floteurs à découper

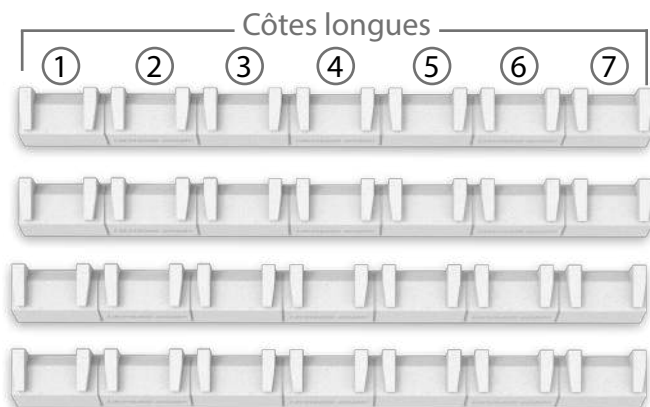

4

Floteurs entiers

Découpe des flotteurs pour Lucernario aerante inox sur mesure

Dénombrer les ouvertures d'aérations par groupe d'aération

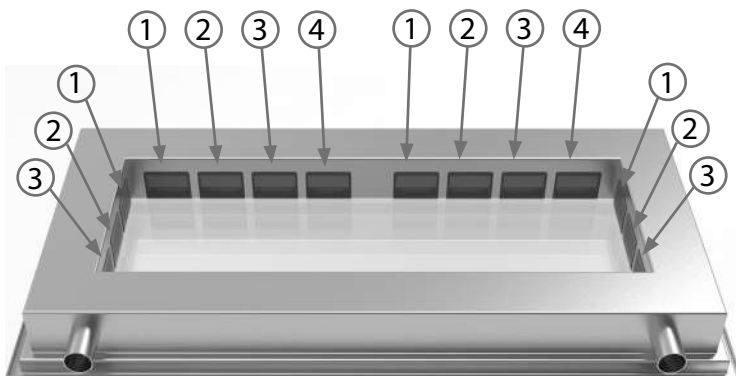

Dans l'exemple ci-dessus, vous avez deux groupes de quatre ouvertures d'aération et deux groupes de trois ouvertures d'aérations. Voici un exemple de coupe.

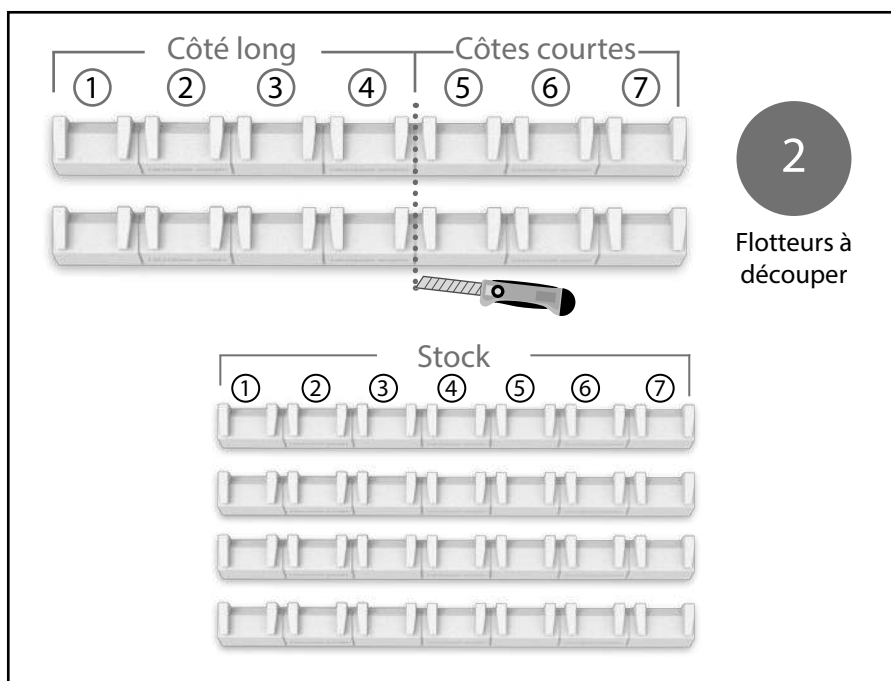

Procédure d'installation

Positionnement des flotteurs

Pour une installation correcte, insérez les flotteurs de manière à ce que la partie plate soit orientée vers les aérations. Assurez-vous de pouvoir lire l'inscription «Lucernario aerante».

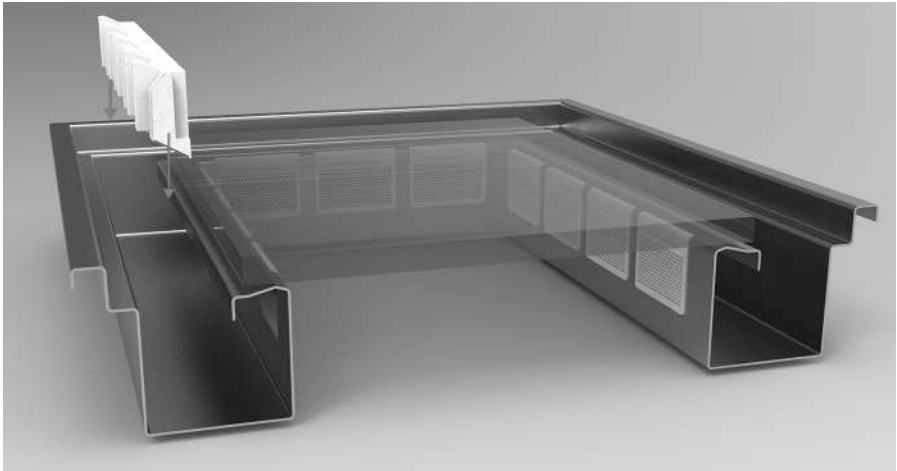

Posez le flotteur sur les aérations.

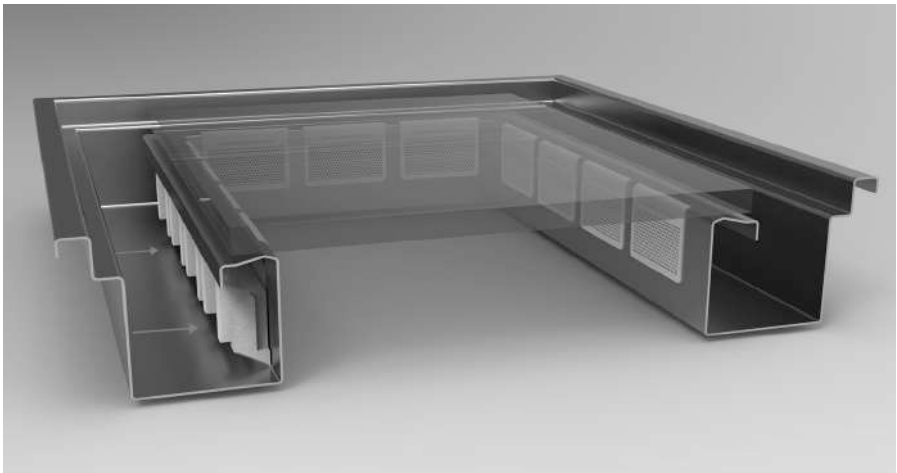

Positionnement des supports de guidage

Inclinez les supports de guidage pour les insérer dans la rainure.

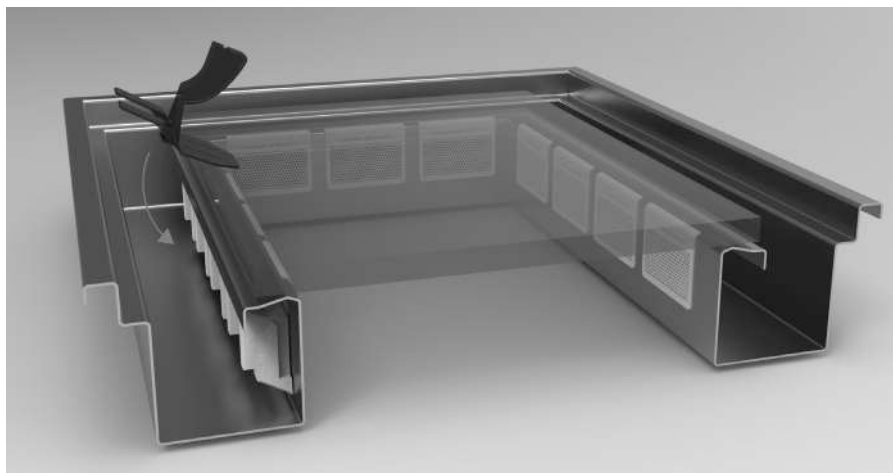

Alignez les repères des supports de guidage avec ceux de la structure du Lucernario Aerante inox.

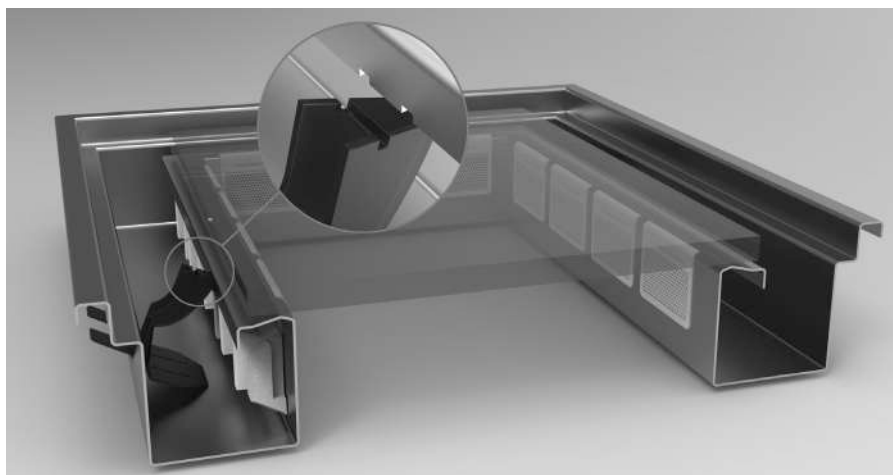

Indice

pag. 91 - Notas importantes sobre cómo funciona Aguastop

pag. 93 - Contenido de la caja

pag. 94 - Corte de los flotadores

pag. 95 - Guías modelo por modelo

pag. 109 - Instalación

IT

EN

DE

FR

ES

NL

GR

TR

Notas importantes sobre el funcionamiento del sistema Aguastop

El sistema antiinundación Aguastop de Lucernario Aerante evita la inundación del sótano en caso de bloqueo del sistema de drenaje. Aguastop actúa cuando aumenta el nivel de agua dentro del canal de ventilación. Los soportes guía tienen la función de guiar Aguastop desde la posición de reposo horizontal a la posición de trabajo vertical, lo que cierra el paso de aire, impidiendo la entrada de agua en las estancias inferiores.



El cierre de las rejillas de ventilación es efectivo pero no total, pueden pasar gotas y pequeños chorros de agua incluso cuando el Aguastop ha alcanzado la posición de trabajo. Después de cada fenómeno es necesario devolver manualmente el Aguastop a la posición de reposo horizontal.



Posibles averías

El sistema anti-inundaciones Aguastop no es infalible. Existen algunas condiciones que pueden impedir que el sistema funcione correctamente, pero se pueden prevenir con pequeñas operaciones de mantenimiento que se realizarán periódicamente.

Limpieza

La suciedad que se acumula en el canal de ventilación del Lucernario Aerante puede obstruir el flotador Aguastop durante su recorrido hasta la posición de trabajo. Hojas, piedras, agujas de pino o pelos de animales pueden quedar alojados en el interior del canal de ventilación e impedir el correcto funcionamiento del Aguastop. La limpieza periódica del canal de recogida de suciedad es fundamental para evitar el mal funcionamiento del sistema antiinundaciones Aguastop.

Sedimentos pegajosos que retienen el flotador

Puede suceder que el flotador Aguastop, si se deja demasiado tiempo en posición de reposo, se adhiera al fondo del canal de ventilación del Lucernario Aerante y quede retenido cuando sea necesario levantarlo para alcanzar la posición de trabajo. Al realizar la limpieza periódica del canal de ventilación de suciedad es necesario mover el flotador para asegurar que nada lo retenga en la posición de reposo horizontal.

Fenómenos meteorológicos adversos

El sistema anti-inundación Aguastop fue diseñado para evitar daños en caso de inundaciones por condiciones climáticas adversas. Sin embargo, existe una infinidad de posibles consecuencias que puede tener un evento atmosférico y no es posible predecir ni excluir que durante un evento de tormenta o inundación, el agua arrastra escombros o lodo que bloquean el recorrido del flotador dejándolo inoperativo.

En la foto el banco de pruebas Aguastop

Contenido de la caja

Flotador

6

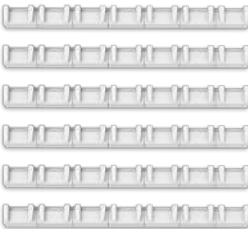

Soporte-guía

12

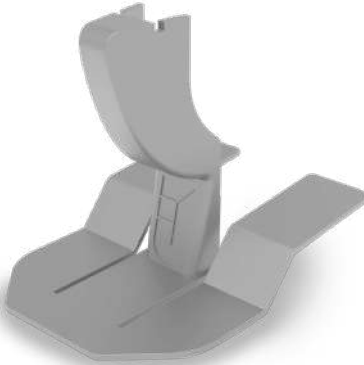

Cortar los flotadores

Paso 1 - Identifica tu modelo de Lucernario Aerante INOX



Modelo	Tamaño	
XS55	55	130
XS85	85	130
S65	65	150
S85	85	150
M65	65	170
L65	65	190

Modelo	Tamaño	
XS66	66	130
XS96	96	130
S76	76	150
S96	96	150
M76	76	170
L76	76	190

Paso 2 - Instrucciones generales de corte

COMO CORTAR

Localice la línea de corte en el flotador.
Apoyándose en una superficie plana, con una cuchilla afilada,
haga un corte limpio y recto.

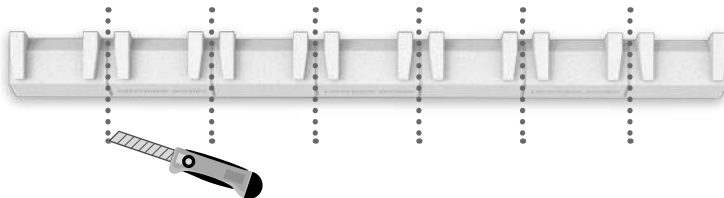

DONDE CORTAR

Continúa la guía modelo por modelo

Modelo XS55

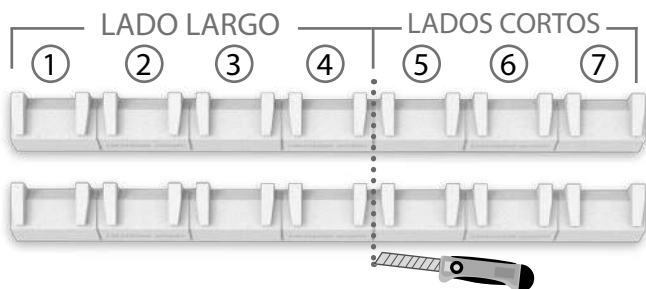

2

Flotadores
para cortar

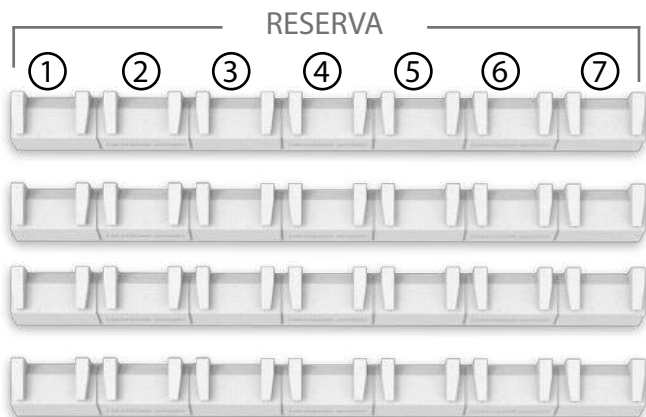

Modelo XS85

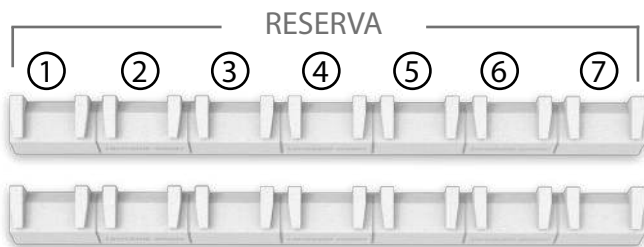
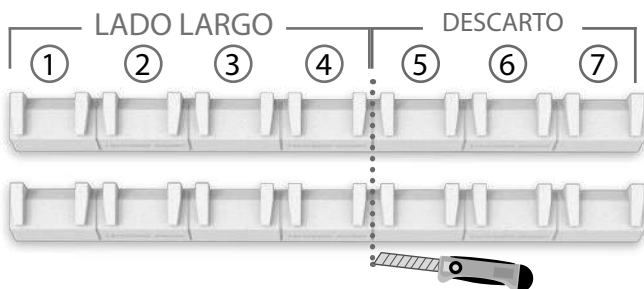

4

Flotadores para cortar

Modelo S65

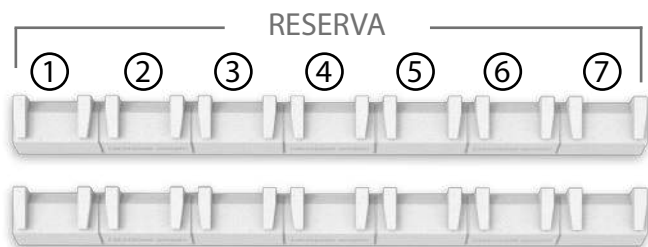
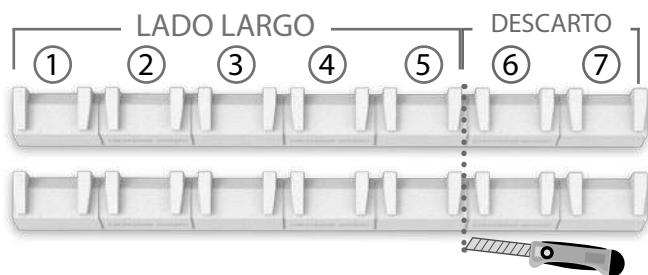
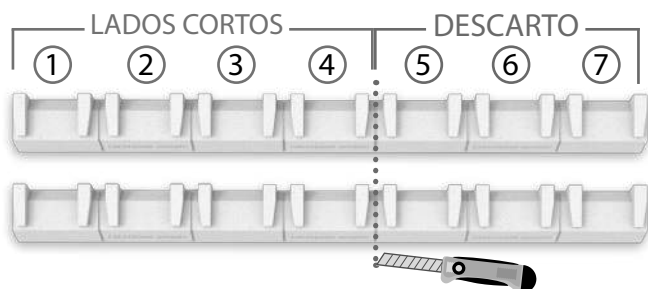

4

Flotadores para cortar

Modelo S85

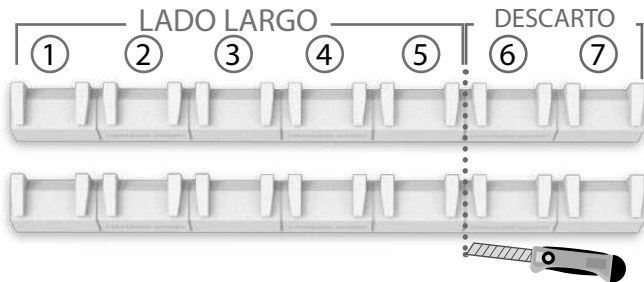
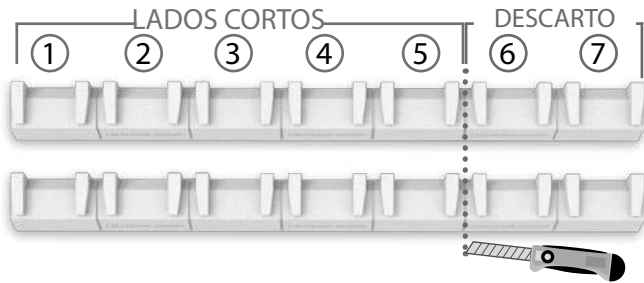

4

Flotadores
para cortar

Modelo M65

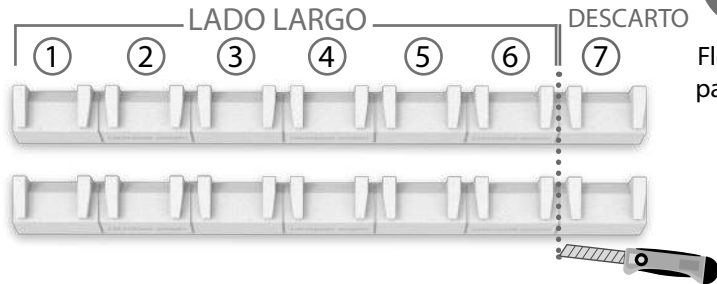
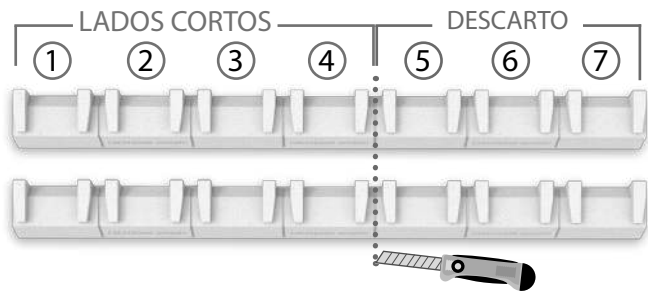

4

Flotadores
para cortar

Modelo L65

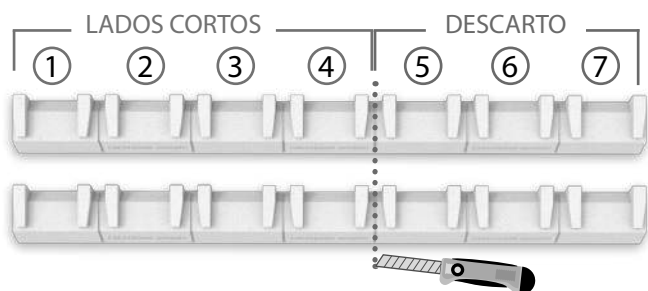

2

Flotadores
para cortar



2

Flotadores
enteros

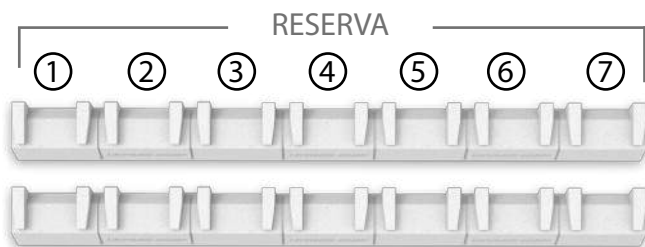

Modelo XS66

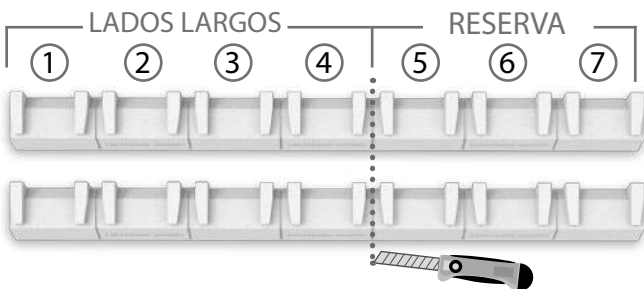
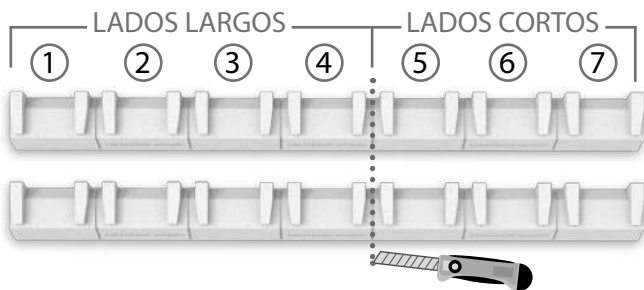

4

Flotadores
para cortar

Modelo XS96

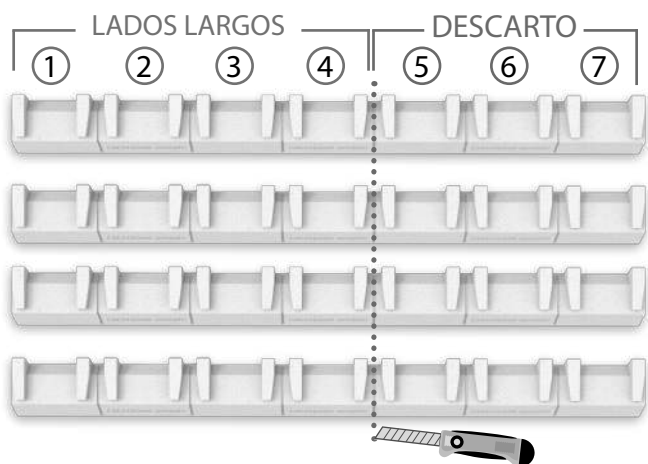

6

Flotadores
para cortar

Modelo S76

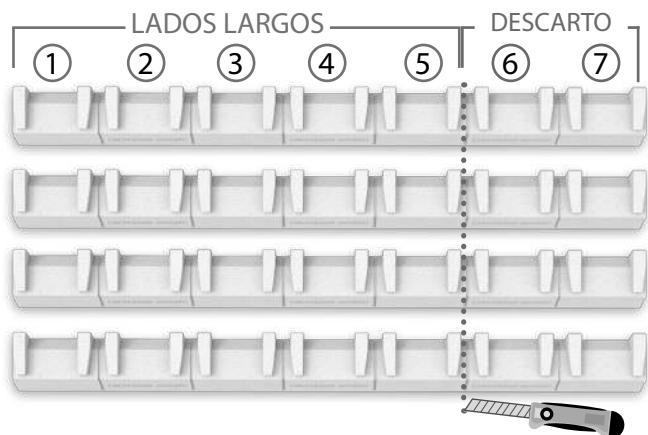
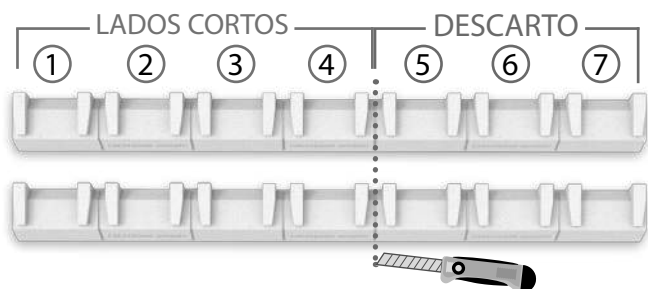

6

Flotadores
para cortar

Modelo S96

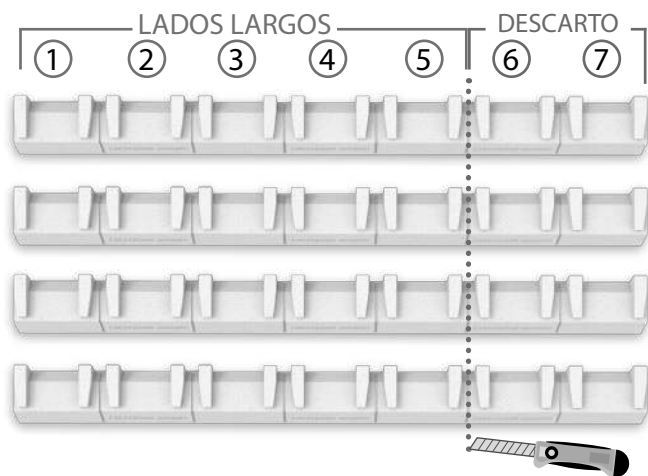

Flotadores
para cortar

Modelo M76

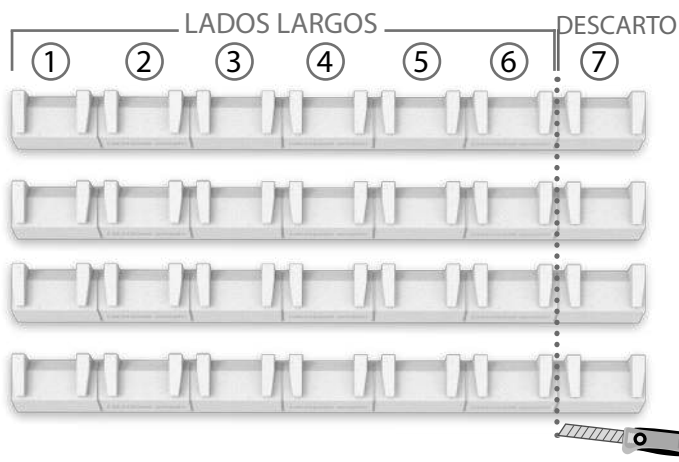
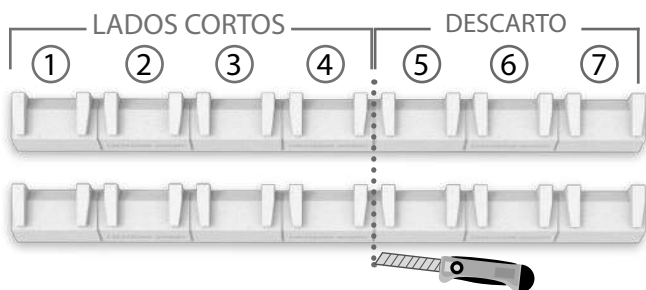

Flotadores
para cortar

Modelo L76

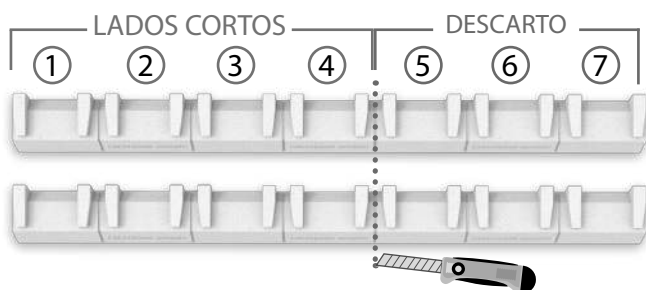

2

Flotadores para cortar

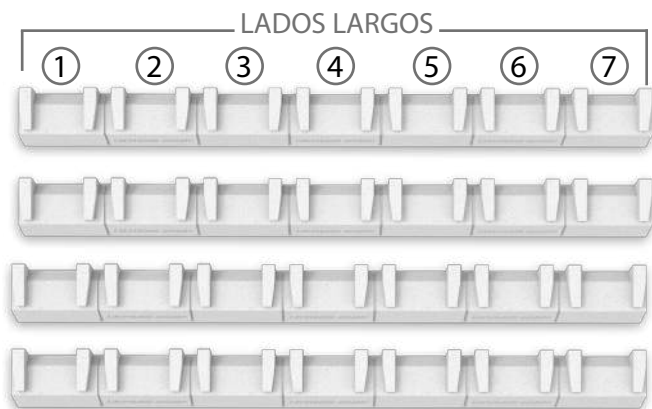

4

Flotadores enteros

Corte de los flotadores para Lucernario Aerante INOX a medida

Cuente el número de rejillas de ventilación para cada grupo

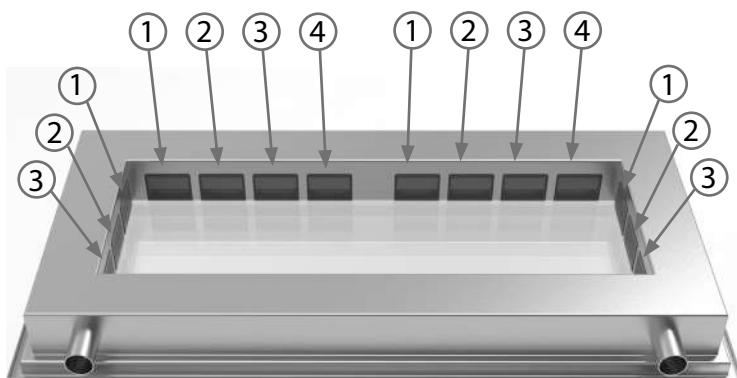

En el ejemplo anterior tenemos dos grupos de 4 rejillas de ventilación y dos grupos de 3 rejillas de ventilación, a continuación un ejemplo de corte.

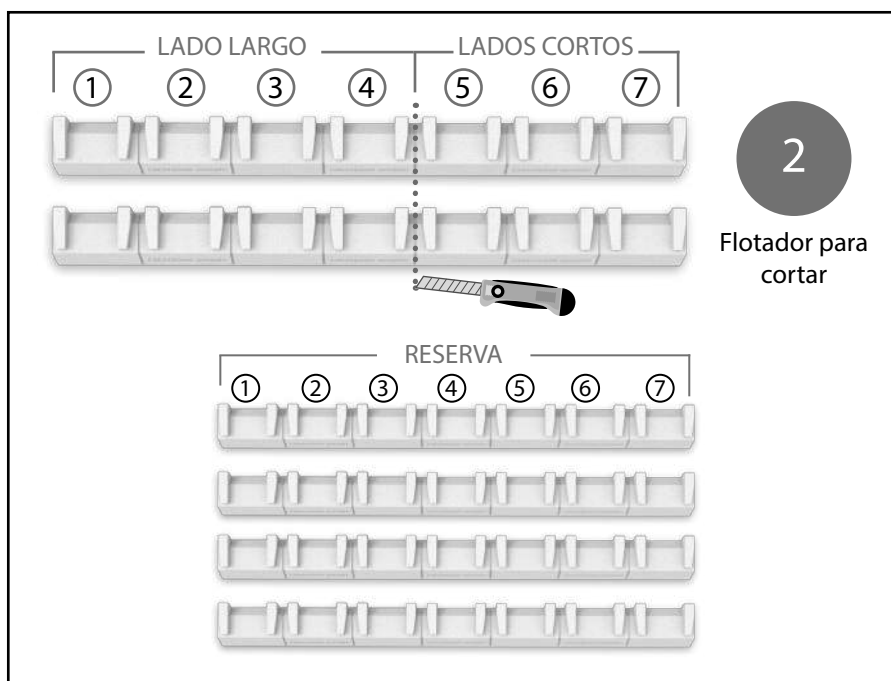

Instalación

Posicionamiento de los flotadores

Para saber si la dirección es correcta, asegúrese de poder leer la marca de Lucernario Aerante mientras inserta el flotador con el lado plano hacia las rejillas de ventilación.

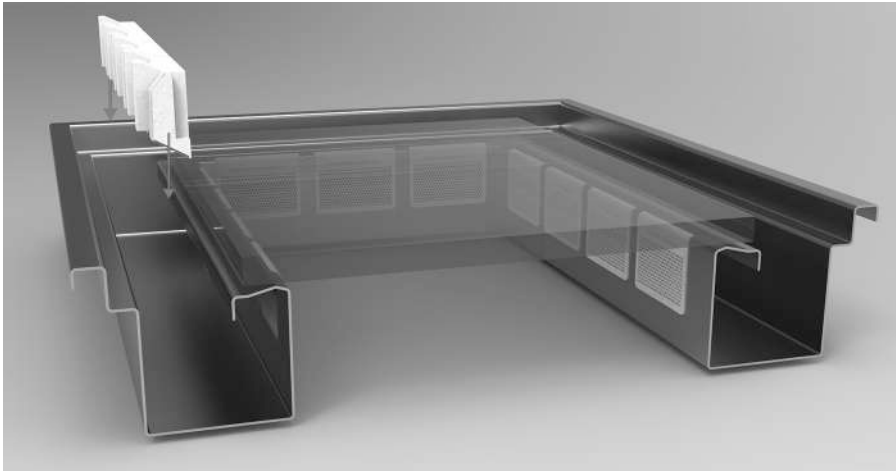

Apoya el flotador a las rejillas de ventilación.

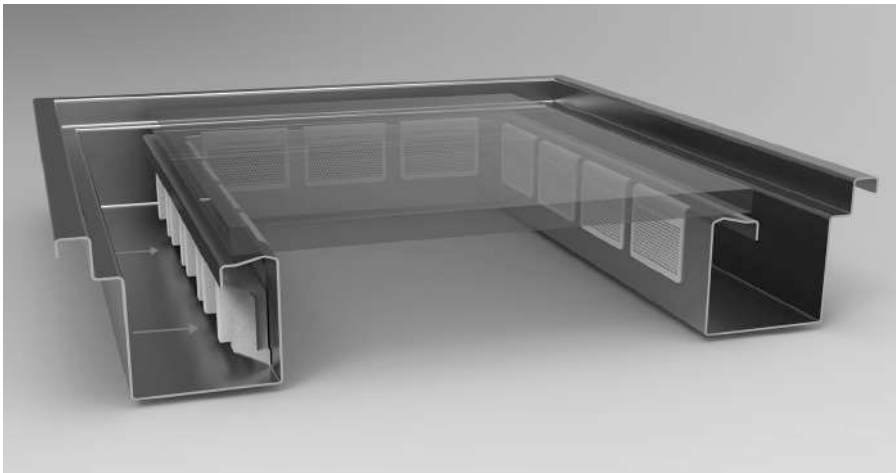

Posicionamiento de los soportes-guía

Incline los soportes-guía para insertarlos en la canal.

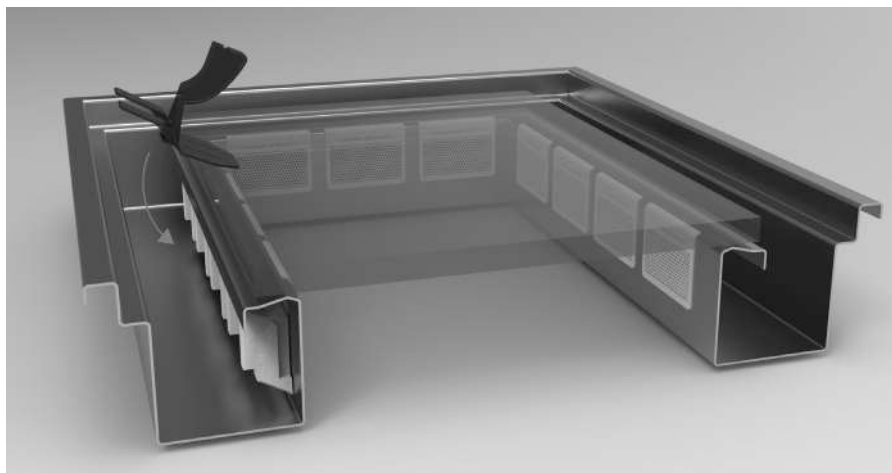

Haga coincidir las muescas de los soportes-guía con las de la estructura de Lucernario Aerante INOX.

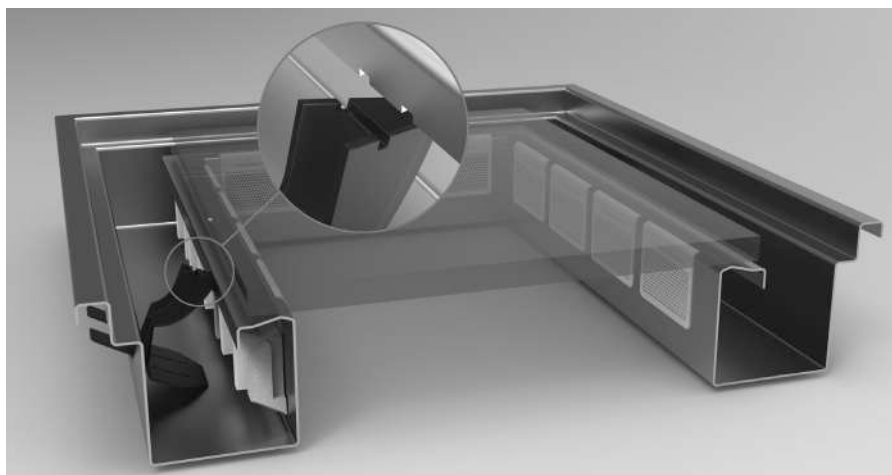

Index

pag. 113 - Belangrijke opmerkingen over de werking van Acquastop

pag. 115 - Inhoud van de doos

pag. 116 - Snit van de vlotters

pag. 117 - Gidsen model per model

pag. 131 - Installatie

IT

EN

DE

FR

ES

NL

GR

TR

Belangrijke opmerkingen over de werking van het Acquastop-systeem

Het anti-overstromingssysteem Acquastop van Lucernario Aerante voorkomt het overstromen van de ventilatieopening (of schacht) als het afvoernetwerk geblokkeerd is. Acquastop werkt door het waterniveau in de ventilatiesleuf te verhogen. De geleidestaven hebben tot taak Acquastop van de horizontale rustpositie naar de verticale werkpositie te geleiden, waardoor de luchtdoorgang afgesloten wordt en wordt voorkomen dat water de onderliggende kamers binnendringt.



De sluiting van de ventilatieopeningen is effectief maar niet volledig; er kunnen druppels en kleine waterstromen doorheen komen, ook als de Acquastop de werkpositie heeft bereikt. Na elk fenomeen moet Acquastop handmatig terug naar de horizontale rustpositie gebracht worden.



Mogelijke storingen

Het anti-overstromingssysteem Acquastop is niet onfeilbaar. Er zijn enkele omstandigheden die ervoor kunnen zorgen dat het systeem niet correct functioneert, maar deze kunnen voorkomen worden door periodiek klein onderhoud uit te voeren.

Reiniging

Het vuil dat zich ophoopt in de ventilatiesleuf van Lucernario Aerante kan een obstakel vormen voor de Acquastop vlotter tijdens zijn verplaatsing naar de werkpositie. Bladeren, stenen, dennennaalden of dierenharen kunnen zich in de ventilatiesleuven afzetten en kunnen de goede werking van de Acquastop belemmeren. Het periodiek reinigen van het opvangkanaal van het vuil is essentieel om een storing van het anti-overstromingssysteem Acquastop te voorkomen.

Kleverig sediment dat de vlotter vasthoudt

Het kan voorkomen dat de Acquastop-vlotter, als deze te lang in ruststand is gebleven, vastkleeft aan de bodem van de ventilatiesleuf van het Lucernario Aerante en vast blijft zitten op het moment dat hij omhoog zou moeten komen om de werkstand te bereiken. Bij periodieke reiniging van de ventilatiesleuf van het vuil moet de vlotter verplaatst worden om er zeker van te zijn dat niets hem in de horizontale rustpositie houdt.

Ongunstige weersomstandigheden

Het anti-overstromingssysteem Acquastop is ontworpen om schade te voorkomen in het geval van overstromingen als gevolg van ongunstige weersomstandigheden. De mogelijke implicaties die een atmosferische gebeurtenis kan hebben zijn echter oneindig en het is niet mogelijk te voorspellen of uit te sluiten dat tijdens een storm of overstroming, het water vuil of modder met zich mee brengt die het traject van de vlotter blokkeert, waardoor de werking ervan inefficiënt wordt.

Op de foto de testbank van Acquastop

Inhoud van de doos

Vlotter

6

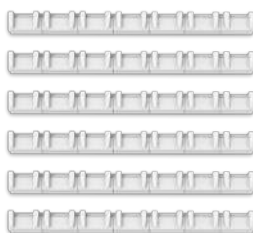

Staaf-geleider

12

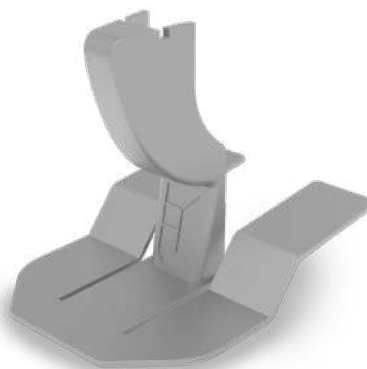

Snit van de vlotters

Stap 1 - Identificeer uw model Lucernario Aerante INOX



Model	Afmetingen	
XS55	55	130
XS85	85	130
S65	65	150
S85	85	150
M65	65	170
L65	65	190

Model	Afmetingen	
XS66	66	130
XS96	96	130
S76	76	150
S96	96	150
M76	76	170
L76	76	190

Stap 2 - Algemene snijinstructies

HOE TE SNIJDEN

Zoek de snijlijn op de vlotter.

Gebruik een vlakke ondergrond en een scherp mes om een zuivere, rechte sneede te maken.

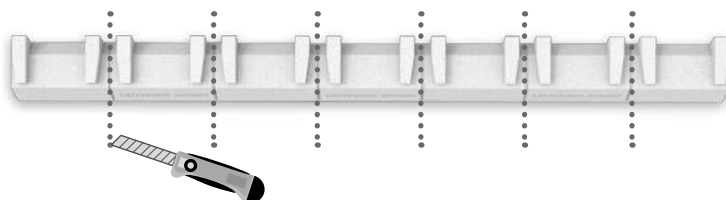

WAAR SNIJDEN

Vervolg gids model per model

Model XS55

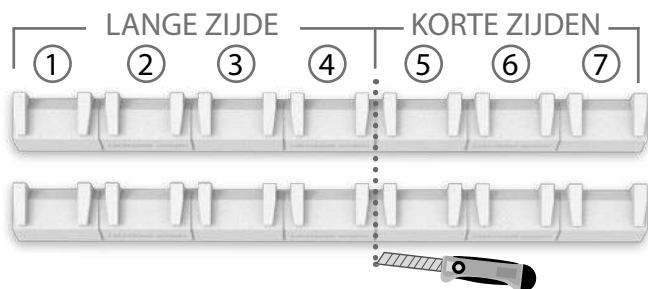

2

Te snijden
vlotters

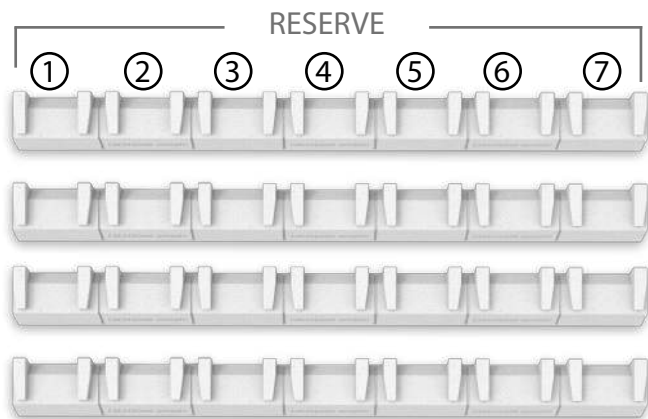

Model XS85

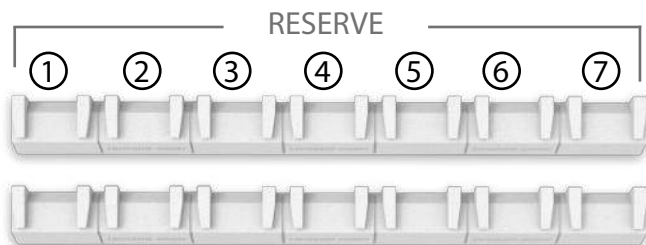
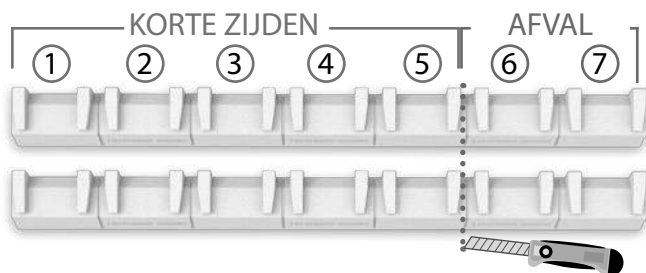
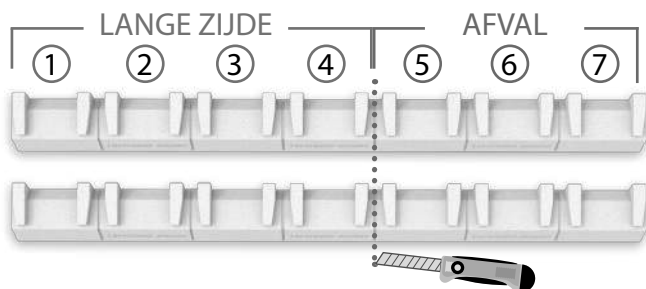

4

Te snijden
vlotters

Model S65

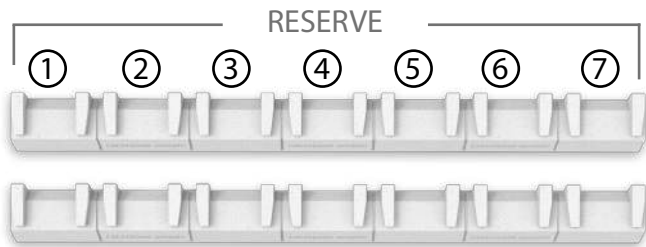
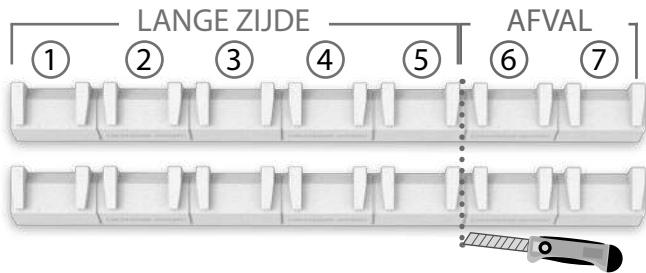
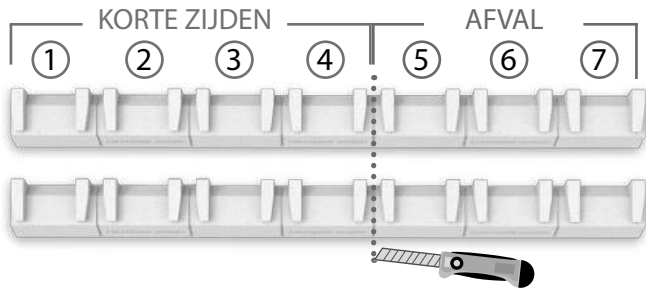

4

Te snijden
vlotters

Model S85

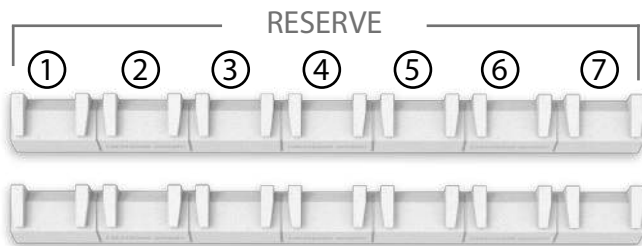
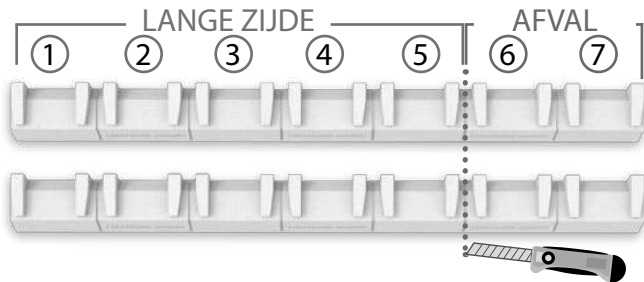
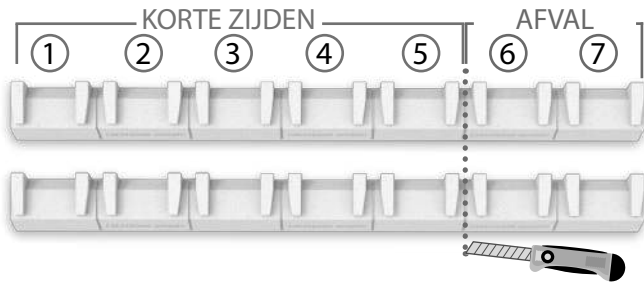

4

Te snijden
vlotters

Model M65

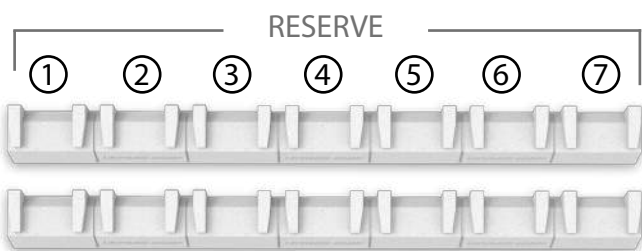
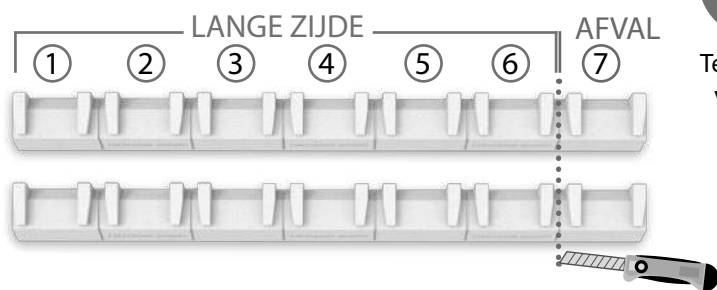
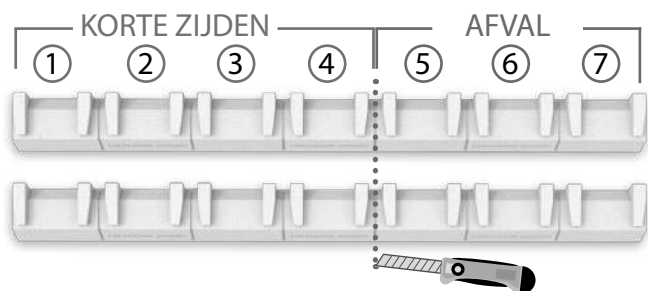

4

Te snijden vlotters

Model L65

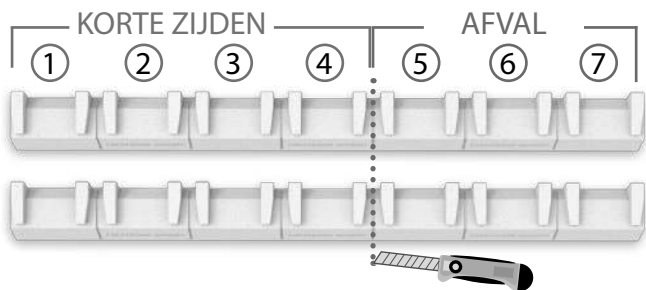

2

Te snijden
vlotters



2

Hele vlotters

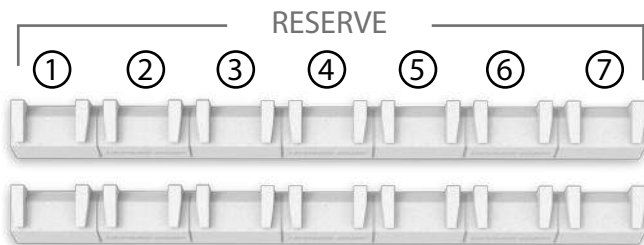

Model XS66

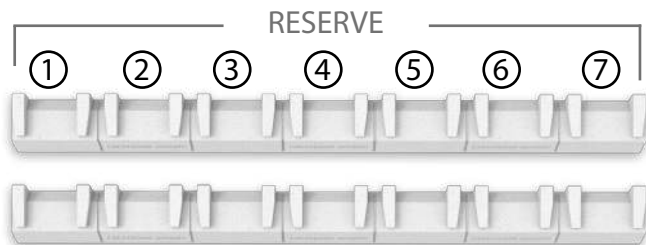
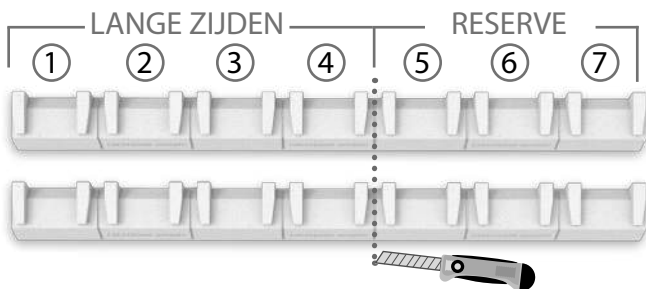
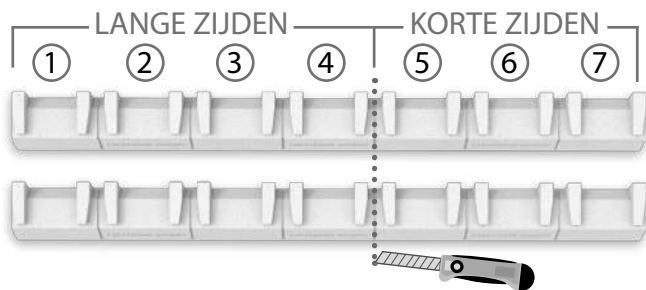

4

Te snijden
vlotters

Model XS96

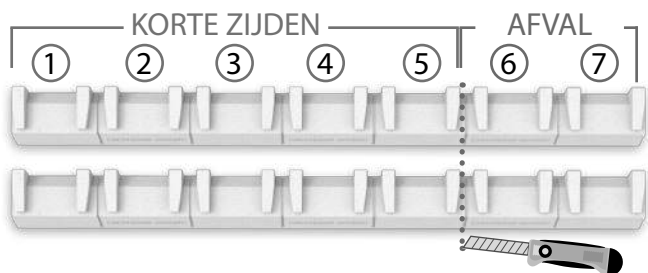
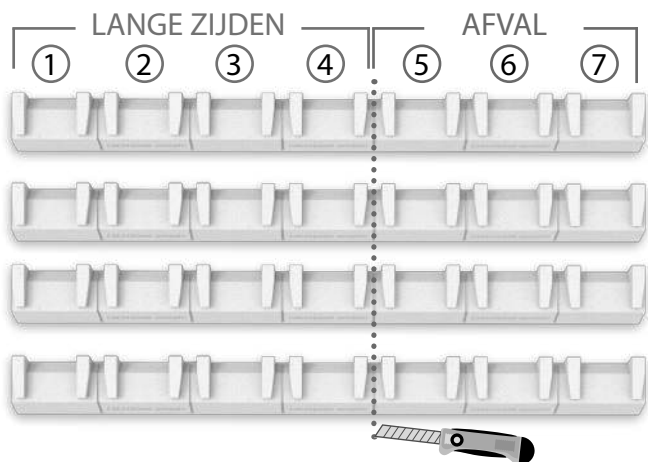

6

Te snijden
vlotters

Model S76

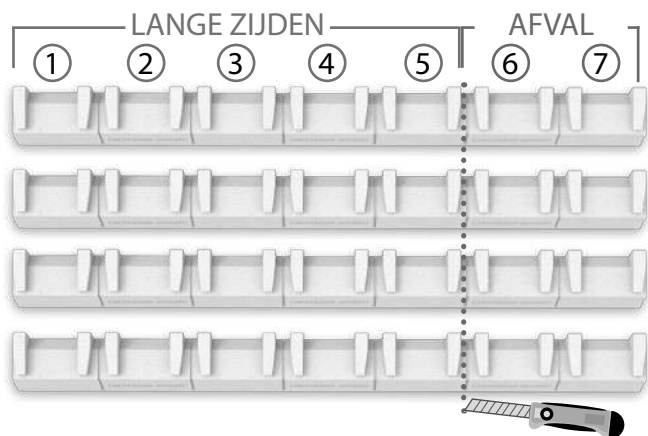
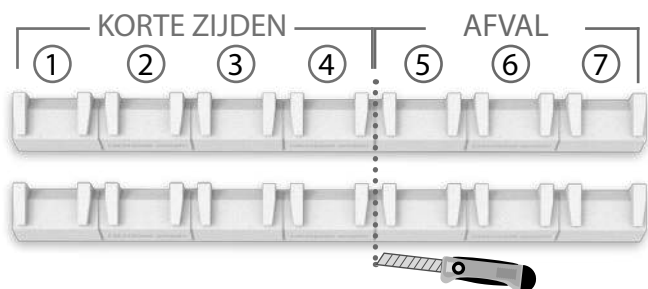

6

Te snijden
vlotters

Model S96

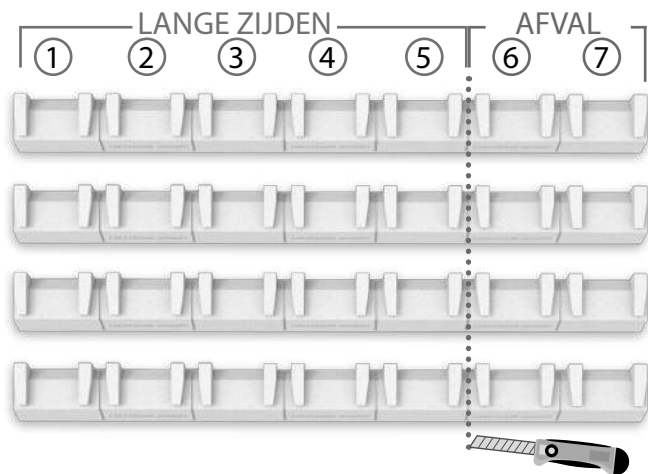
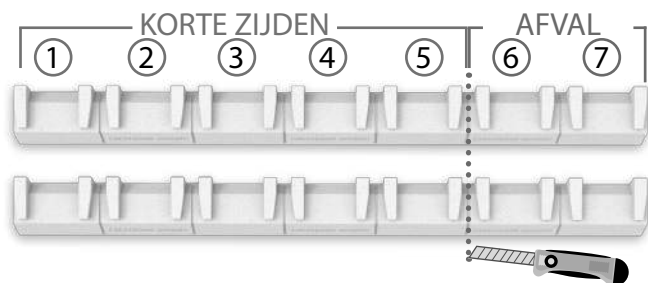

6

Te snijden
vlotters

Model M76

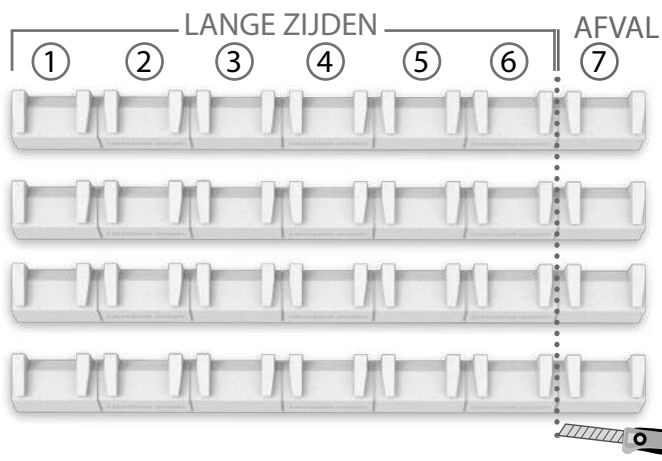
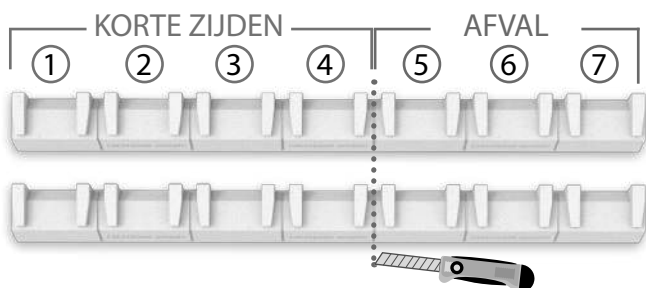

6

Te snijden
vlotters

Model L76

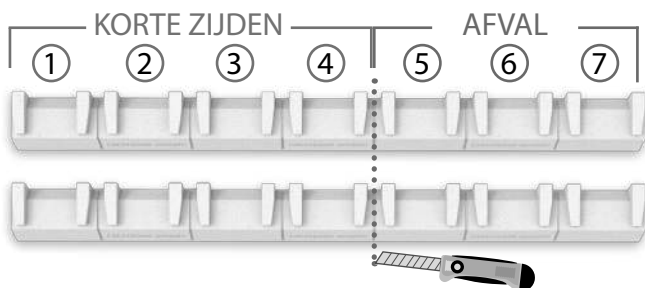

2

Te snijden
vlotters

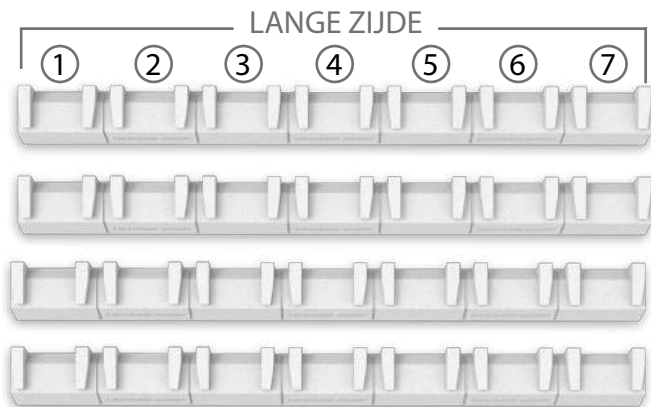

4

Hele vlotters

Snit op maat van de vlotters voor Lucernario Aerante INOX

Tel het aantal ventilatieopeningen voor elke ventilatiegroep

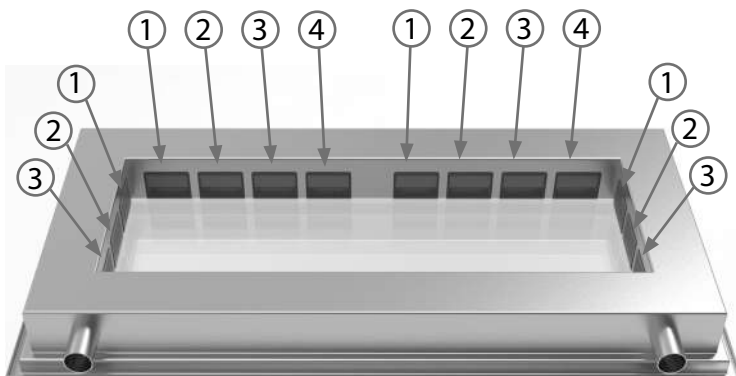

In het bovenstaande voorbeeld hebben we twee groepen van 4 ventilatieopeningen en twee groepen van 3 ventilatieopeningen, hieronder een voorbeeld van snit.

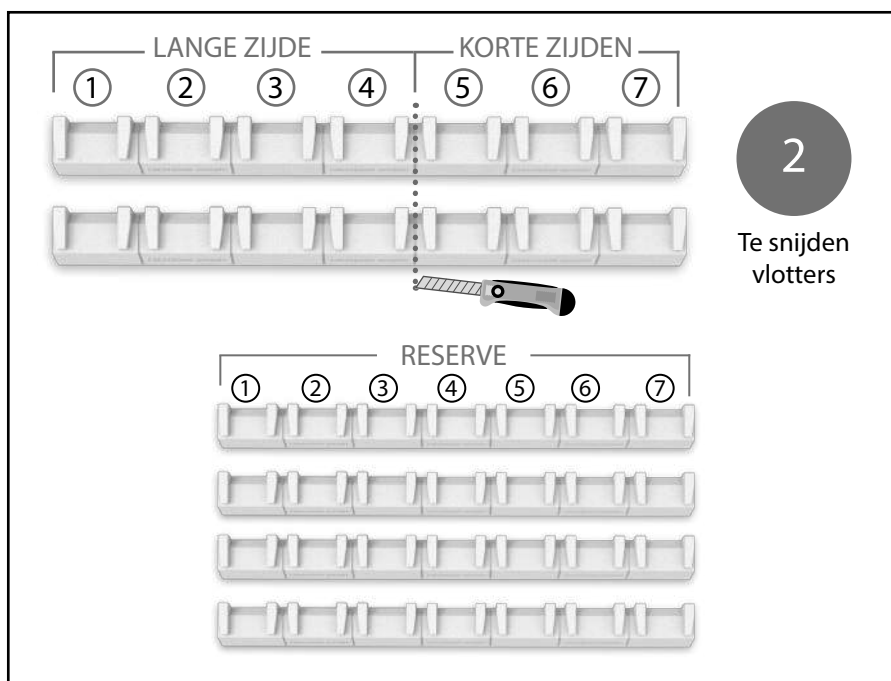

Installatie

Plaatsing van de vlotters

Om te weten welk de juiste richting is, zorg ervoor dat u het merk Lucernario Aerante kunt lezen terwijl u de vlotter plaatst met het platte gedeelte naar de ventilatieopeningen gericht.

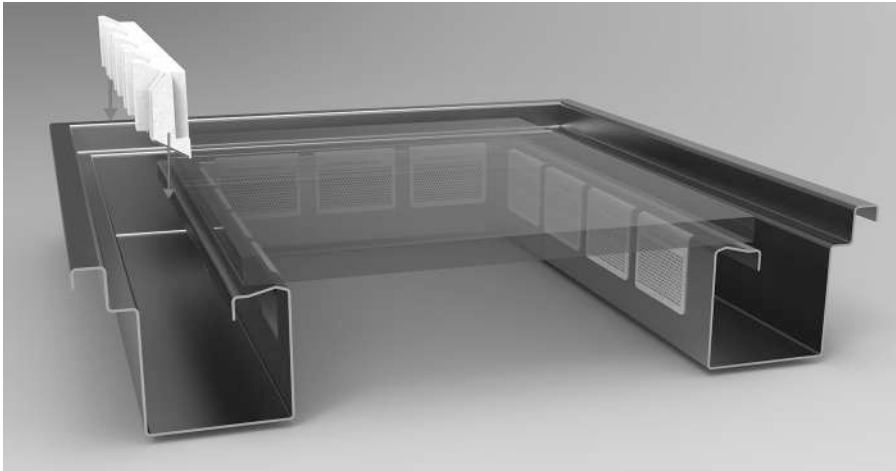

Plaats de vlotter op de ventilatieopeningen

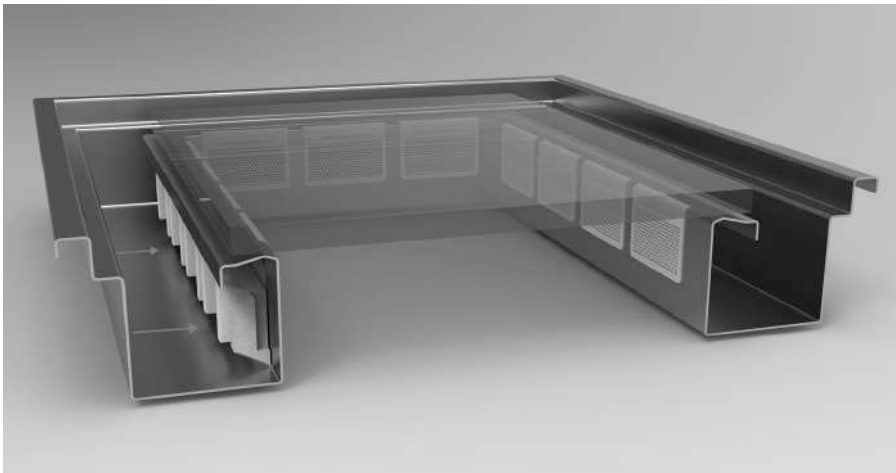

Plaatsing van de geleidestaven

Kantel de geleidestaven om ze in de sleuf te steken.

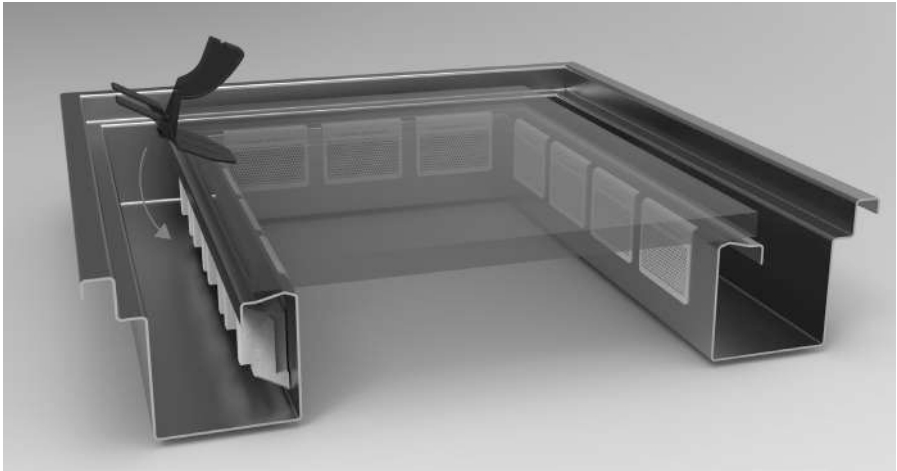

Zorg ervoor dat de inkepingen op de geleidestaven overeenkomen met die op de structuur van Lucernario Aerante INOX.

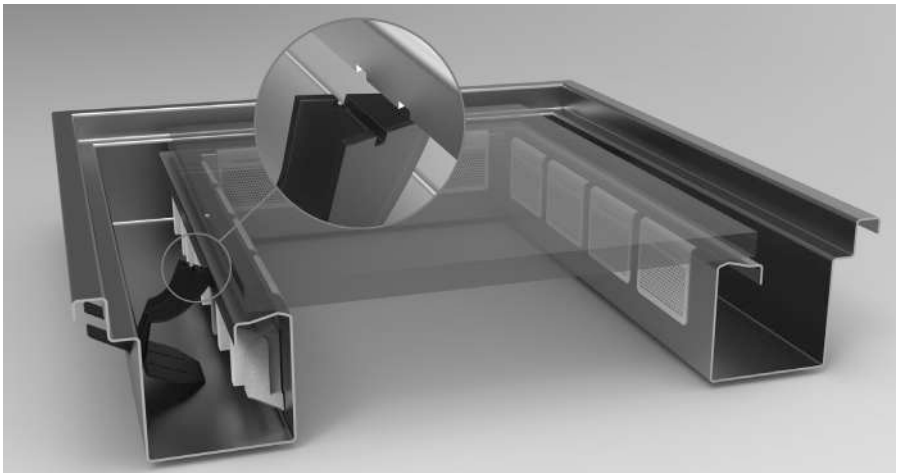

IT

EN

DE

FR

ES

NL

GR

TR

Πίνακας περιεχομένων

σελ. x - Σημαντικές σημειώσεις για τη λειτουργία του Acquastop

σελ. x - Περιεχόμενο του κιβωτίου

σελ. x - Κοπή των πλωτήρων

σελ. x - Οδηγοί ανά μοντέλο

σελ. x - Εγκατάσταση

Σημαντικές σημειώσεις για τη λειτουργία του συστήματος Acquastop

Το αντιπλημμυρικό σύστημα Acquastop του Αεριζόμενου Φωταγωγού προστατεύει τους εσωτερικούς ανοιχτούς χώρους (ή αεραγωγούς) από πλημμύρες σε περίπτωση που το αποχετευτικό δίκτυο είναι βουλωμένο. Το Acquastop δρα με την αύξηση της στάθμης του νερού μέσα στο αυλάκι αερισμού. Οι βάσεις-οδηγοί έχουν τη λειτουργία να οδηγούν το Acquastop από την οριζόντια θέση ακινητοποίησης στην κάθετη θέση λειτουργίας, που κλείνει τη διέλευση του αέρα, αποτρέποντας την είσοδο του νερού στους χώρους που βρίσκονται από κάτω.



Το κλείσιμο των παροχών αέρα είναι επαρκές αλλά όχι ολοκληρωτικό, σταγόνες και μικρές ροές νερού μπορούν να περάσουν ακόμη και όταν το Acquastop έχει φθάσει στη θέση λειτουργίας. Μετά από κάθε φαινόμενο είναι απαραίτητο να επαναφέρετε με το χέρι το Acquastop σε οριζόντια θέση ακινητοποίησης.



Πιθανές δυσλειτουργίες

Το αντιπλημμυρικό σύστημα Acquastop δεν είναι αλάνθαστο. Υπάρχουν ορισμένες συνθήκες που μπορούν να αποτρέψουν τη σωστή λειτουργία του συστήματος, αλλά μπορούν να προληφθούν με μικρές συντηρήσεις που πρέπει να εκτελούνται περιοδικά.

Καθαρισμός

Η ακαθαρσία που συσσωρεύεται μέσα στο αυλάκι αερισμού του Αεριζόμενου Φωταγωγού μπορεί να παρεμποδίσει τον πλωτήρα του Acquastop κατά την πορεία του προς τη θέση λειτουργίας. Φύλλα, πέτρες, πευκοβελόνες ή τρίχες από ζώα μπορούν να κατακαθίσουν μέσα στο αυλάκι αερισμού και μπορούν να παρεμποδίσουν τη σωστή λειτουργία του Acquastop. Ο περιοδικός καθαρισμός του καναλιού συλλογής της ακαθαρσίας είναι απαραίτητος ώστε να προληφθεί τυχόν δυσλειτουργία του αντιπλημμυρικού συστήματος Acquastop.

Κολλώδη ιζήματα που συγκρατούν τον πλωτήρα

Può verificarsi che il galleggiante di Acquastop, se rimasto in posizione di riposo per troppo tempo, si appiccichi al fondo del fossetto di ventilazione del Lucernario Aerante e rimanga trattenuto nel momento in cui è necessario che si alzi per portarsi in posizione di lavoro. Quando si effettua la pulizia periodica del fossetto di ventilazione dello sporco è necessario muovere il galleggiante per assicurarsi che nulla lo trattenga in posizione orizzontale di riposo.

Αντίξοα ατμοσφαιρικά φαινόμενα

Το αντιπλημμυρικό σύστημα Acquastop έχει σχεδιαστεί για την πρόληψη ζημιών από πλημμύρα λόγω αντίξοων ατμοσφαιρικών συνθηκών, ωστόσο είναι άπειρες οι πιθανές συνέπειες που μπορεί να έχει ένα ατμοσφαιρικό φαινόμενο και δεν είναι δυνατόν να προβλεφθεί, ούτε να αποκλειστεί, ότι κατά τη διάρκεια μιας πλημμύρας, καταιγίδας ή υπερχειλίσης, το νερό μπορεί να φέρει μαζί του απορρίμματα ή λάσπη που να εμποδίζουν την πορεία του πλωτήρα ακυρώνοντας τη λειτουργία του.

Στη φωτογραφία η κλίνη δοκιμής του Acquastop

Περιεχόμενο του κιβωτίου

Πλωτήρας

6

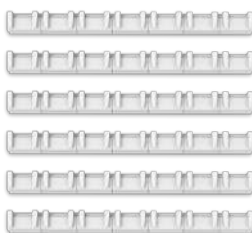

Βάση-οδηγός

12

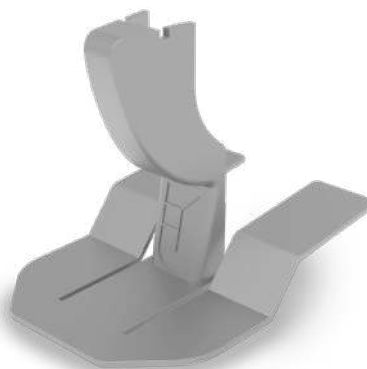

Κοπή των πλωτήρων

Βήμα 1 - Προσδιορίστε το μοντέλο σας Αεριζόμενου Φωταγωγού INOX



Μοντέλο	Διαστάσεις	
XS55	55	130
XS85	85	130
S65	65	150
S85	85	150
M65	65	170
L65	65	190

Μοντέλο	Διαστάσεις	
XS66	66	130
XS96	96	130
S76	76	150
S96	96	150
M76	76	170
L76	76	190

Βήμα 2 - Γενικές οδηγίες κοπής

ΤΡΟΠΟΣ ΚΟΠΗΣ

Εντοπίστε τη γραμμή κοπής επάνω στον πλωτήρα.

Ακουμπήστε επάνω σε μία επίπεδη επιφάνεια, με μία ακονισμένη λάμα, κόψτε με ακρίβεια και ίσια.

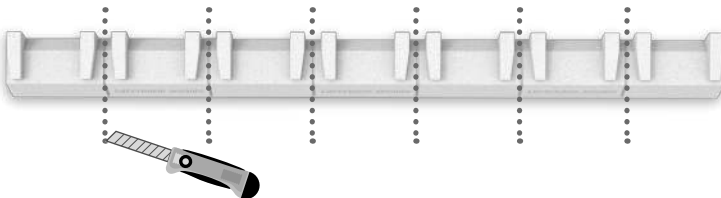

ΠΟΥ ΘΑ ΚΟΨΕΤΕ

Συνεχίζεται ο οδηγός ανά μοντέλο

Μοντέλο XS55

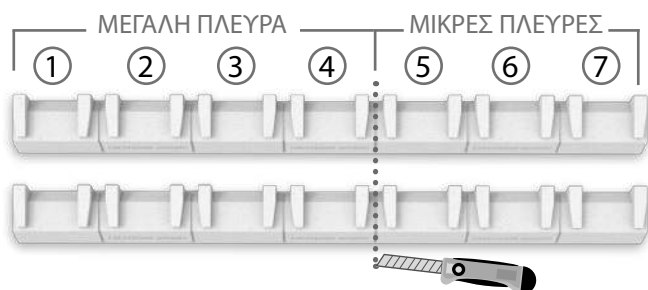

2

Πλωτήρες
προς κοπή

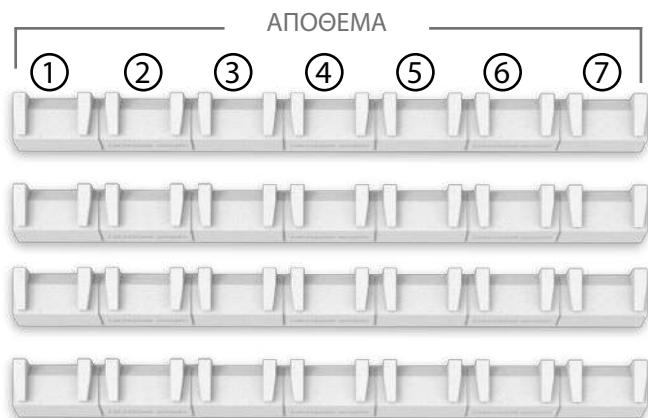

Μοντέλο XS85

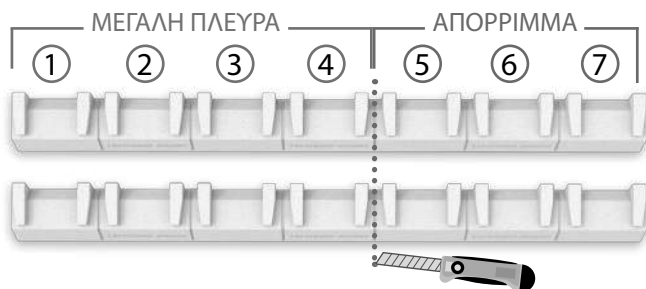

4

Πλωτήρες
προς κοπή

Μοντέλο S65

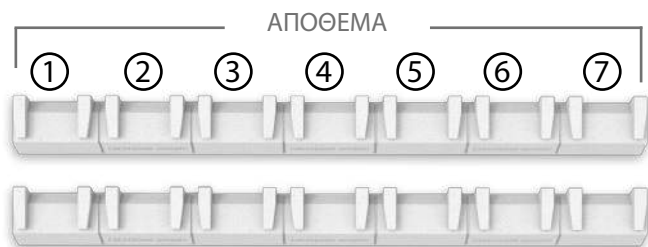
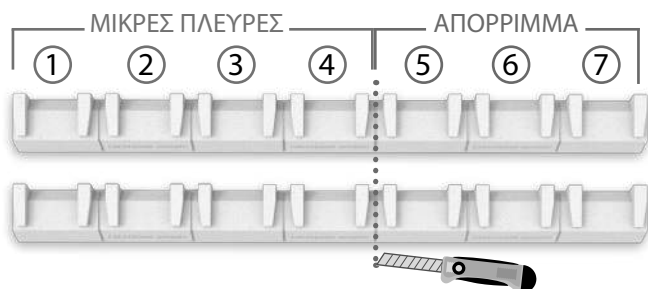

4

Πλωτήρες
προς κοπή

Μοντέλο S85

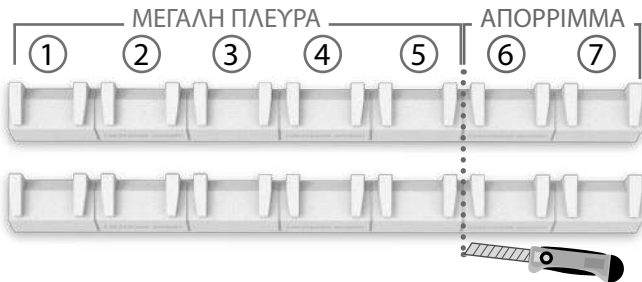
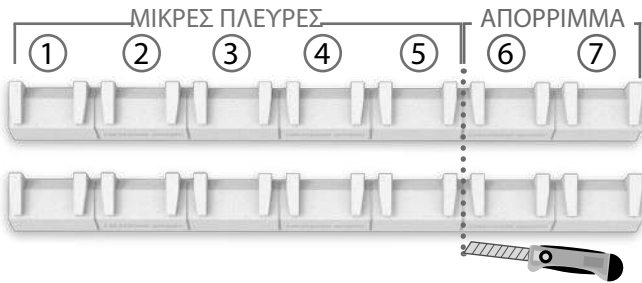

4

Πλωτήρες
προς κοπή

Μοντέλο Μ65

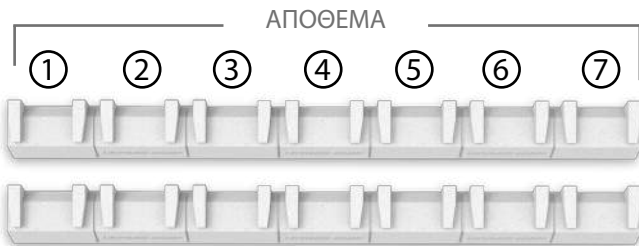
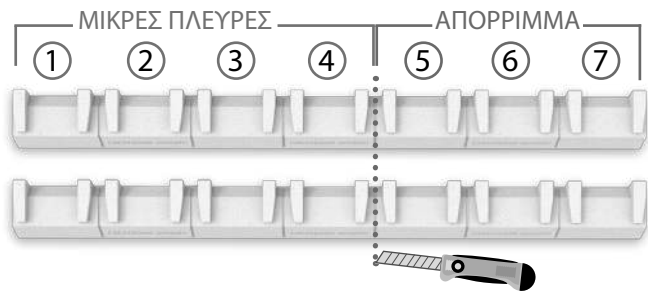

4

Πλωτήρες
προς κοπή

Μοντέλο L65

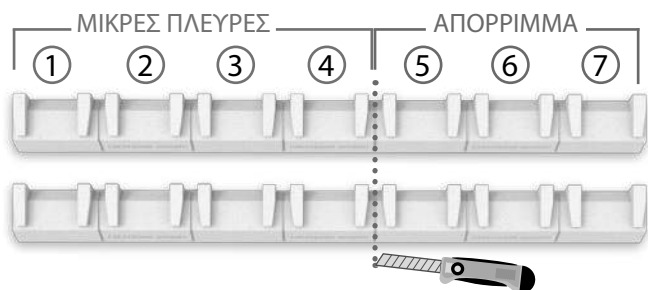

2

Πλωτήρες
προς κοπή



2

Πλωτήρες
ολόκληροι

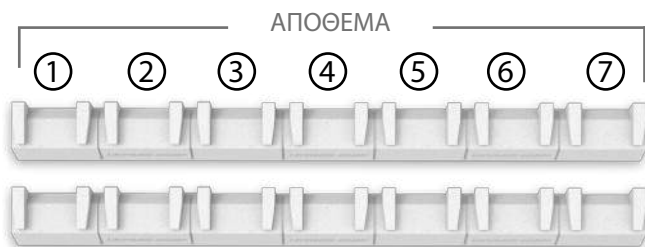

Μοντέλο XS66

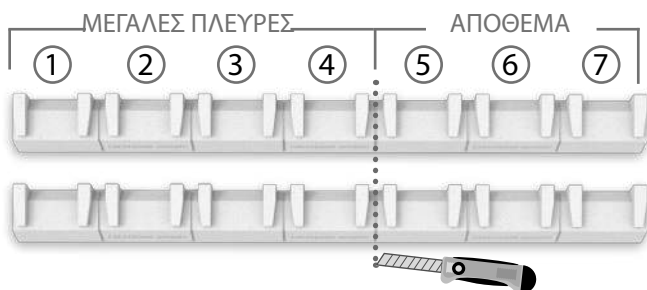
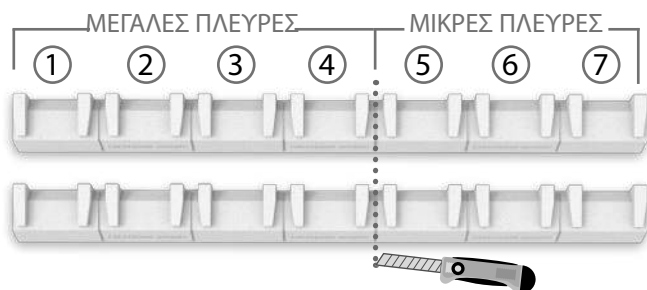

4

Πλωτήρες
προς κοπή

Μοντέλο XS96

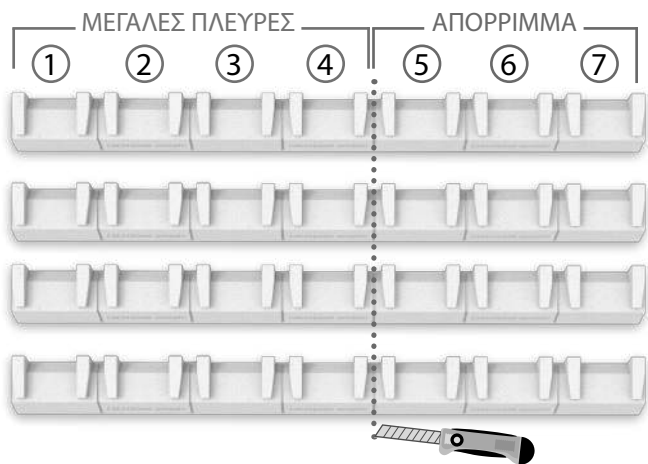

6

Πλωτήρες
προς κοπή

Μοντέλο S76

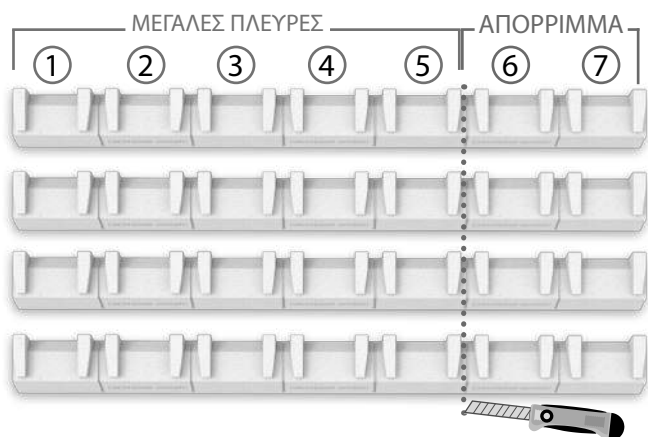
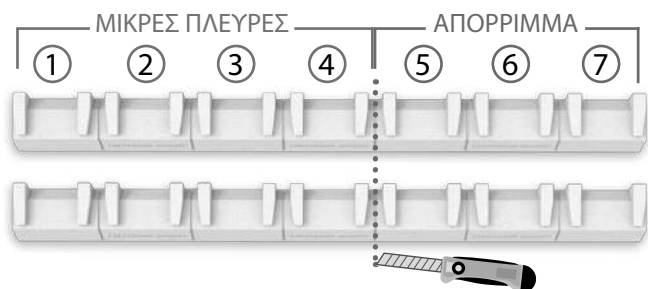

6

Πλωτήρες
προς κοπή

Μοντέλο S96

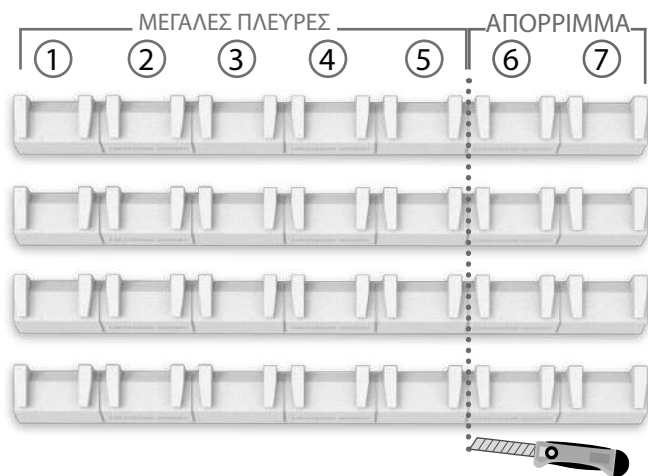

6

Πλωτήρες
προς κοπή

Μοντέλο M76

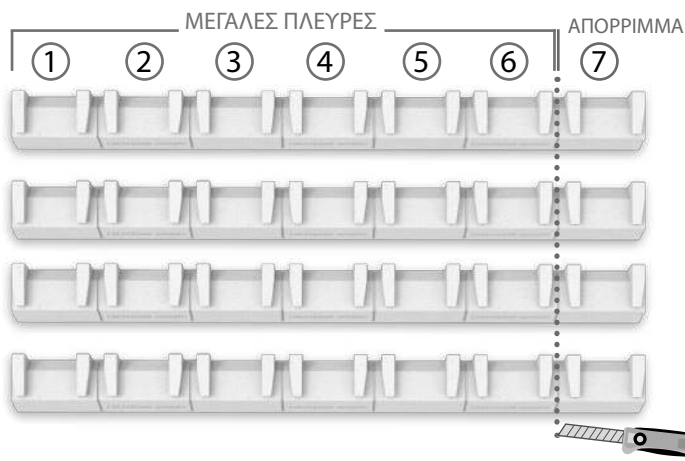
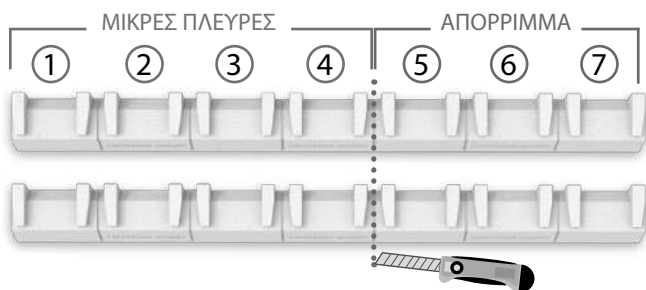

6

Πλωτήρες
προς κοπή

Μοντέλο L76

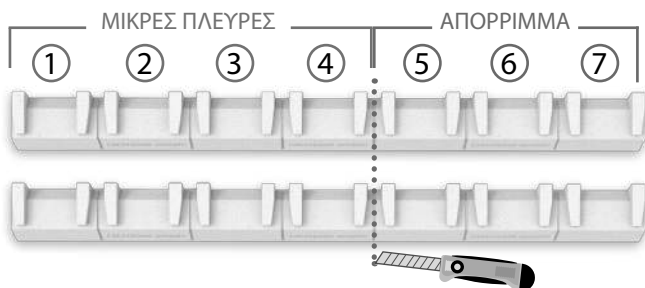

2

Πλωτήρες
προς κοπή

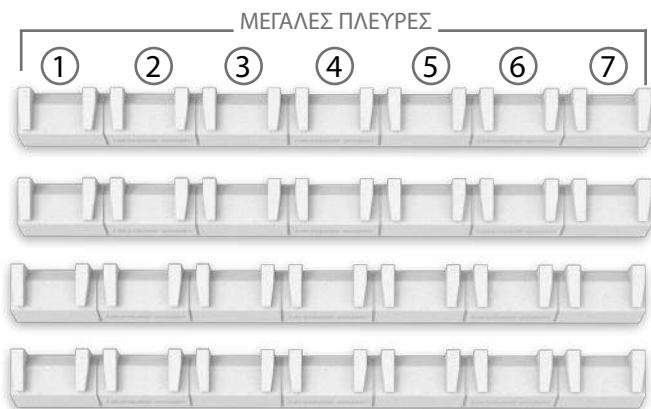

4

Πλωτήρες
ολόκληροι

Κοπή των πλωτήρων για Αεριζόμενο Φωταγωγό INOX κατά παραγγελία

Μετρήστε τον αριθμό παροχών αέρα για κάθε γκρουπ παροχών αέρα

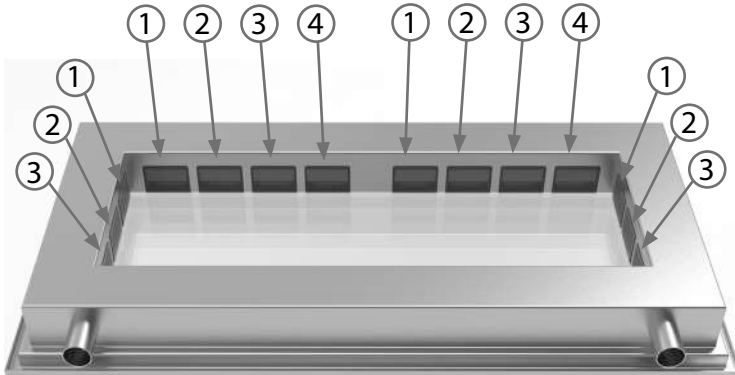

Στο προαναφερόμενο παράδειγμα έχουμε δύο γκρουπ 4 παροχών αέρα και δύο γκρουπ 3 παροχών αέρα, παρακάτω ένα παράδειγμα κοπής.

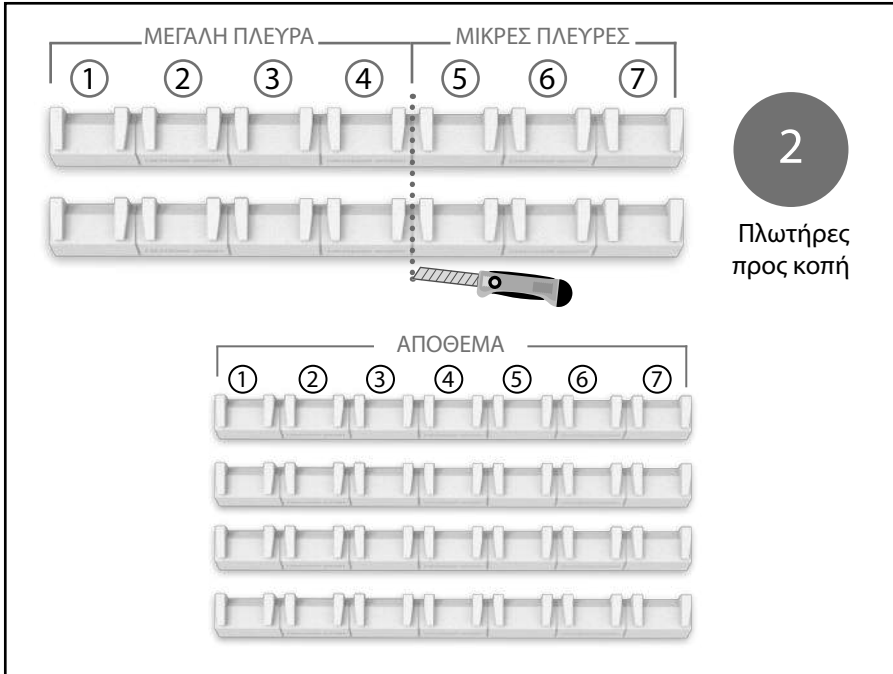

Εγκατάσταση

Τοποθέτηση των πλωτήρων

Για να μάθετε τη σωστή φορά, βεβαιωθείτε ότι μπορείτε να διαβάσετε το σήμα *Lucernario Aerante* ενώ εισάγετε τον πλωτήρα με το επίπεδο μέρος του γυρισμένο προς τις παροχές αέρα.

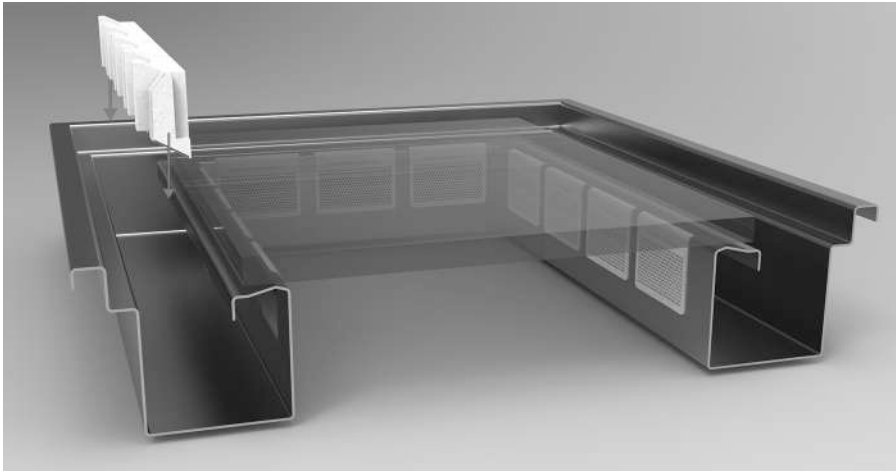

Ακουμπήστε τον πλωτήρα στις παροχές αέρα

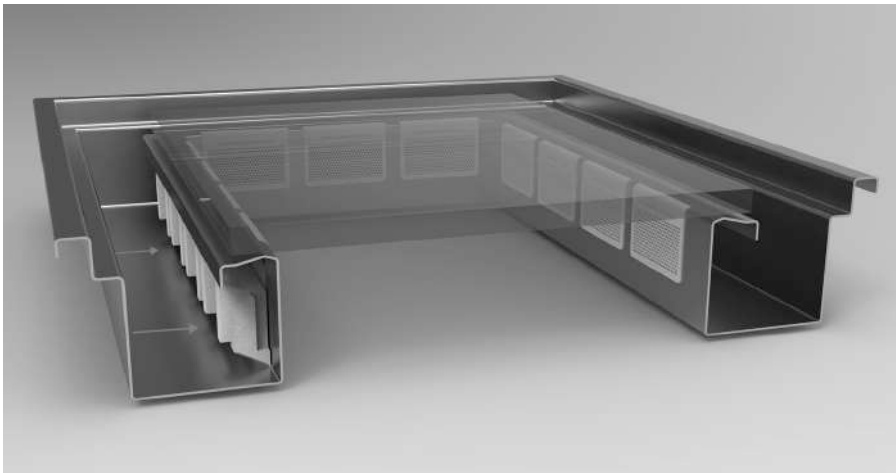

Τοποθέτηση των βάσεων-οδηγών

Κλίνετε τις βάσεις-οδηγούς για να τις τοποθετήσετε εντός του αυλακιού.

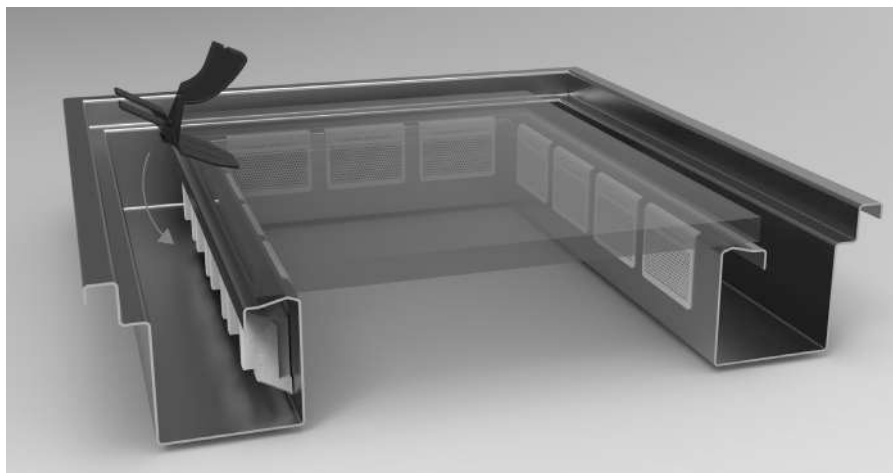

Αντιστοιχίστε τις εγκοπές που υπάρχουν επάνω στις βάσεις-οδηγούς με αυτές που υπάρχουν επάνω στη δομή του Αεριζόμενου Φωταγωγού INOX.

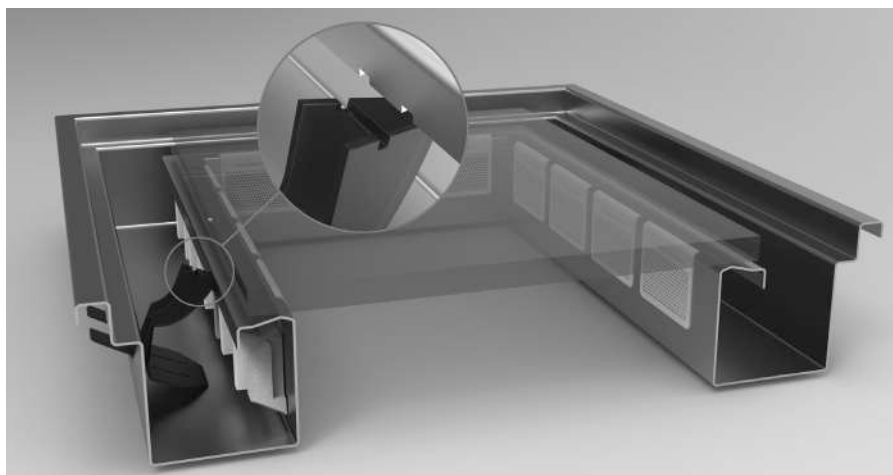

İçindekiler

Sayfa 157 - Aquastop Sistemi Çalışma Prensipleri Hakkında Önemli Notları

Sayfa 159 - Paket İçeriği

Sayfa 160 - Şamandıra Kesimi

Sayfa 161 - Model Bazlı Kullanım Kılavuzları

Sayfa 175 - Kurulum

IT

EN

DE

FR

ES

NL

GR

TR

Aquastop Sistemi Çalışma Prensipleri Hakkında Önemli Notları

Lucernario Aerante INOX'un su baskı sistemi olan Aquastop, tahliye sistemindeki tıkanıklık durumunda ışıklık boşluğunun su basmasını önler.

Aquastop, havalandırma kanalındaki su seviyesinin yükselmesiyle çalışır. Kılavuz braketler, Aquastop'u yatay dinlenme pozisyonundan dikey çalışma pozisyonuna taşıyarak hava geçişini kapatır ve böylece suyun alt katlara girmesini engeller.



Havalandırma açıklıklarının kapanması etkili olsa da tam bir sızdırmazlık sağlamaz. Aquastop çalışma pozisyonundayken bile küçük damlalar veya sızıntılar olabilir. Her olaydan sonra Aquastop'u manuel olarak yatay dinlenme pozisyonuna getirmek gerekir.



Potansiyel Sorunlar

Aquastop su baskın önleme sistemi hatasız değildir. Sistemin doğru çalışmasını engelleyebilecek bazı durumlar olabilir, ancak bu durumlar düzenli küçük bakımlarla önlenebilir.

Temizlik

Lucernario Aerante havalandırma kanalında biriken kir, Aquastop şamandırasının çalışma pozisyonuna hareket etmesini engelleyebilir. Yapraklar, taşlar, çam iğneleri veya hayvan kılı gibi yabancı maddeler havalandırma kanalında birikerek Aquastop'un doğru çalışmasını engelleyebilir. Aquastop su baskın önleme sisteminin arızalanmasını önlemek için kir toplama kanalının düzenli olarak temizlenmesi gereklidir.

Şamandırayı yapıştıran yapışkan tortular

Lucernario Aerante havalandırma kanalının dibinde biriken yapışkan tortular, Aquastop şamandırasının hareket etmesini engelleyebilir. Şamandıra uzun süre hareketsiz kalırsa, kanalın dibine yapışabilir ve çalışması gereken pozisyona gelemeyebilir. Bu nedenle, havalandırma kanalını temizlerken şamandıranın serbestçe hareket ettiğinden emin olmak için kontrol edilmelidir.

Olumsuz hava koşulları

Aquastop su baskın önleme sistemi, olumsuz hava koşullarına bağlı su baskınlarına karşı koruma sağlamak üzere tasarlanmıştır. Ancak, bir hava olayının sonuçları tahmin edilemez ve bir sel, fırtına veya su baskını sırasında suyun, şamandıranın hareketini engelleyebilecek çamur veya enkaz taşınması olasılığı her zaman vardır.

Resimde Aquastop test cihazı gösterilmektedir

Kutu İeriđi

Őamandıra

6

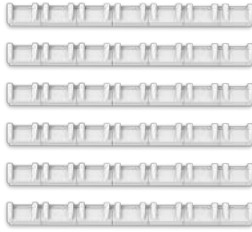

Kılavuz braketi

12

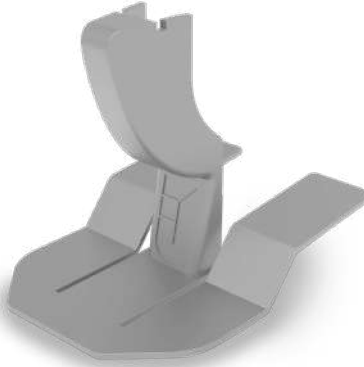

Şamandıra Kesimi

Adım 1: Kendi Lucernario Aerante INOX modelinizi belirleyin

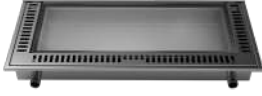

Model	Boyutlar	
XS55	55	130
XS85	85	130
S65	65	150
S85	85	150
M65	65	170
L65	65	190

Model	Boyutlar	
XS66	66	130
XS96	96	130
S76	76	150
S96	96	150
M76	76	170
L76	76	190

Adım 2: Genel kesim talimatları

Nasıl kesilir

Kesim çizgisini bulun: Şamandıra üzerindeki kesim çizgisini belirleyin.
Kesin: Şamandırayı düz bir yüzeye yerleştirin ve keskin bir bıçak kullanarak temiz ve düz bir kesim yapın.

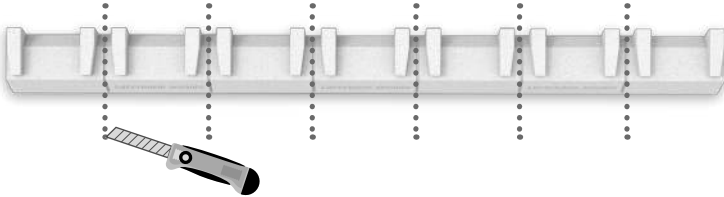

Nereden kesilir

Modelinize özel kılavuzu takip edin

Model XS55

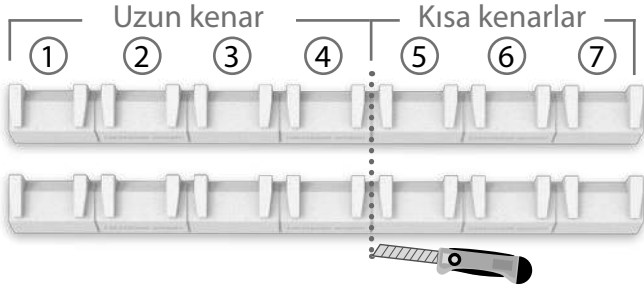

2
Tam
şamandıra

Model XS85

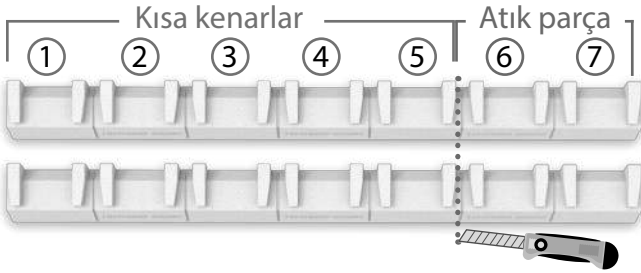
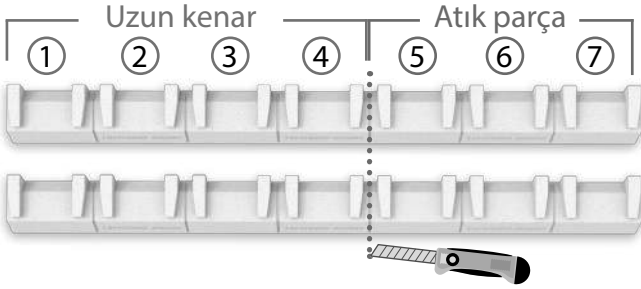

4

Kesilecek
şamandıra

Model S65

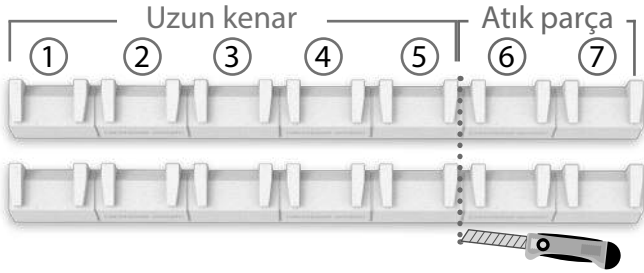
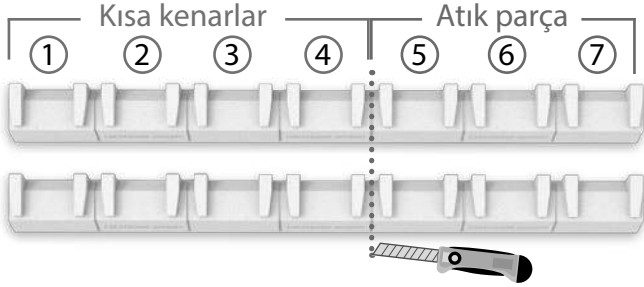

4

Kesilecek
şamandıra

Model S85

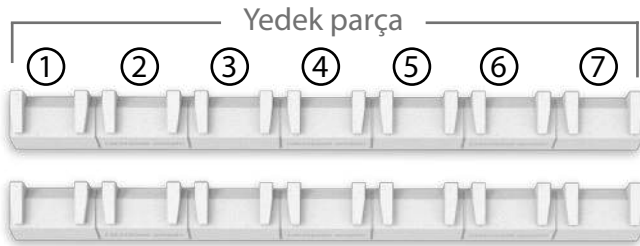
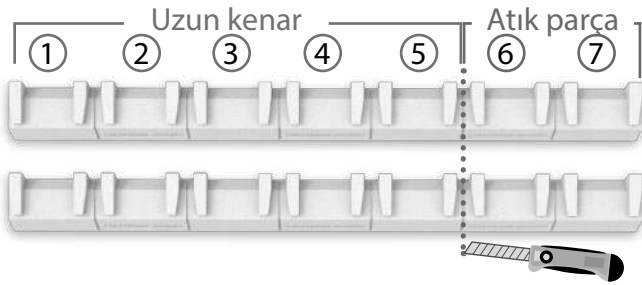
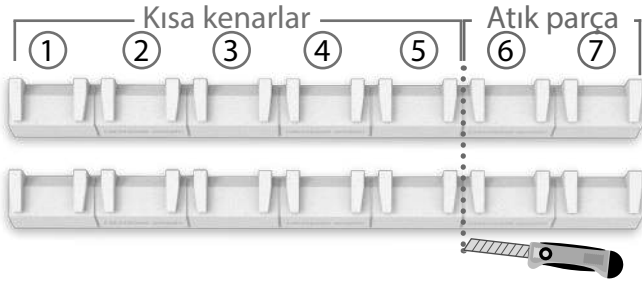

4

Kesilecek
şamandıra

Model M65

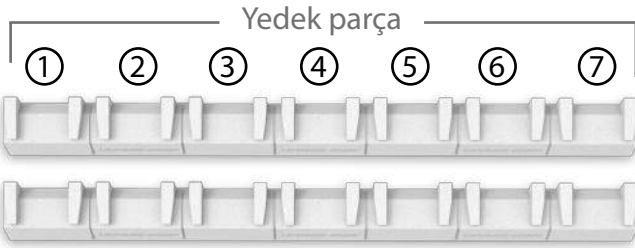
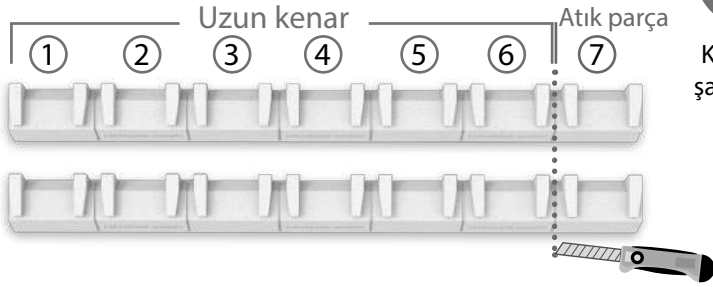
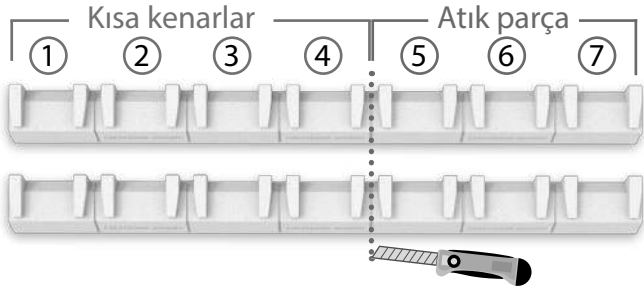

4

Kesilecek
şamandıra

Model L65

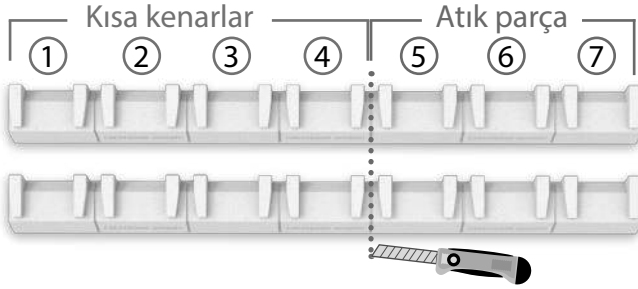

2

Kesilecek
şamandıra

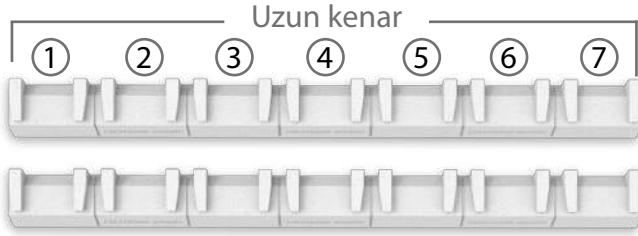

2

Tam şamandıra

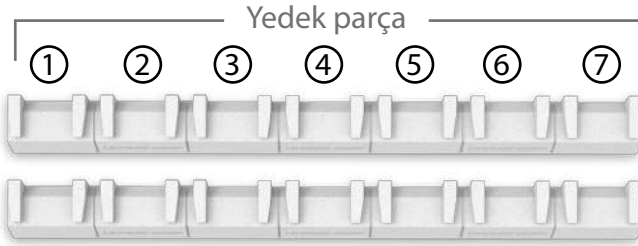

Model XS66

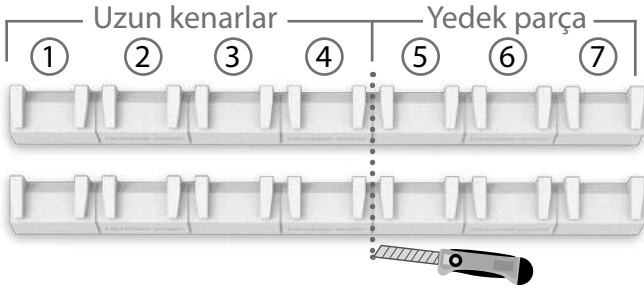
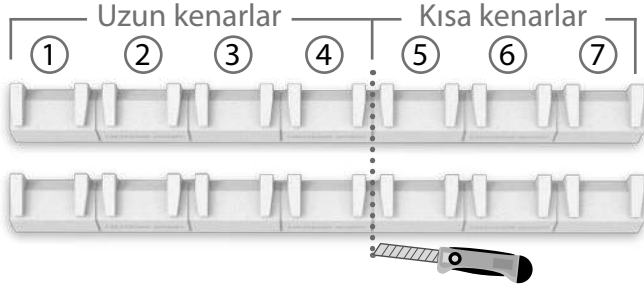

4

Kesilecek
şamandıra

Model XS96

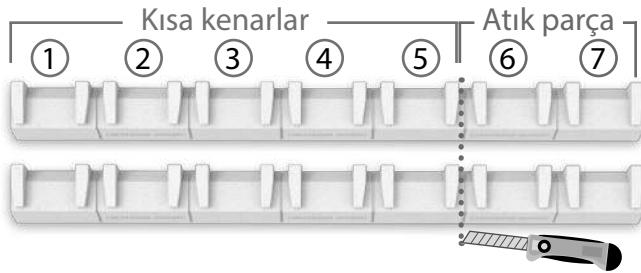
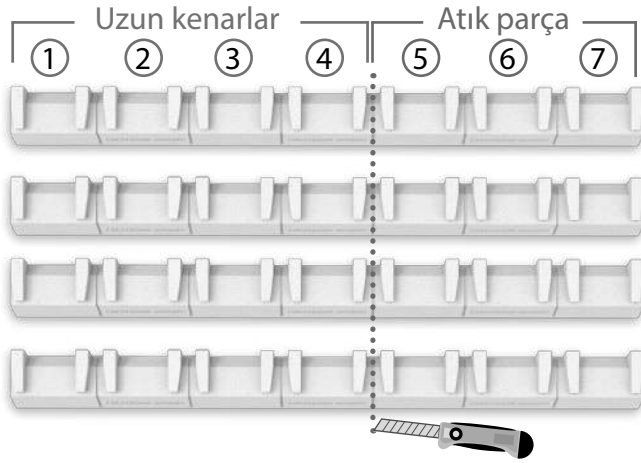

6

Kesilecek
şamandıra

Model S76

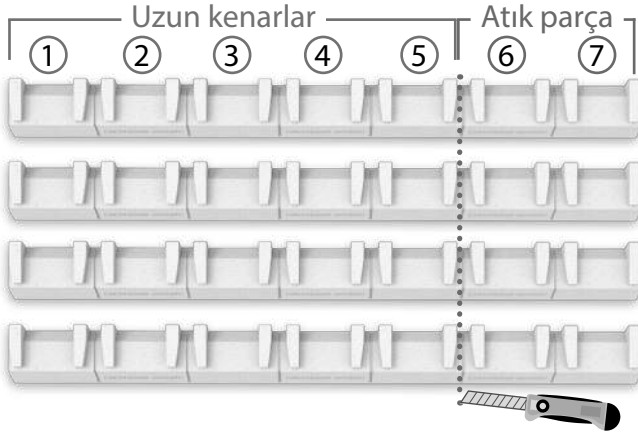
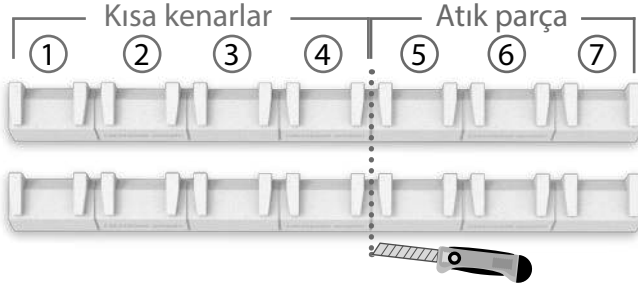

6

Kesilecek
şamandıra

Model S96

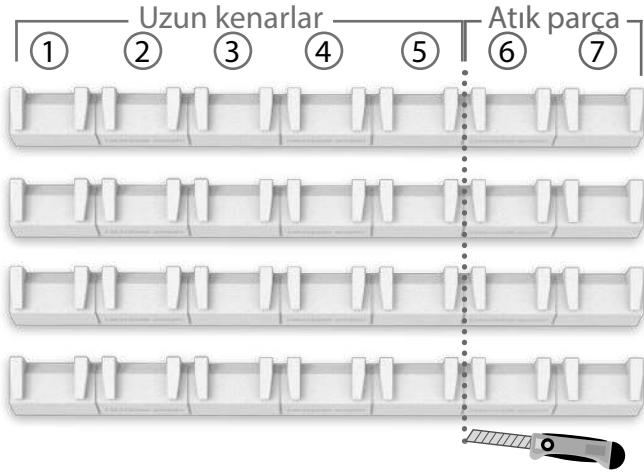
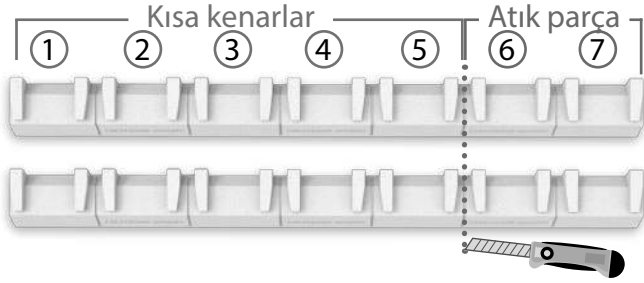

6

Kesilecek
şamandıra

Model M76

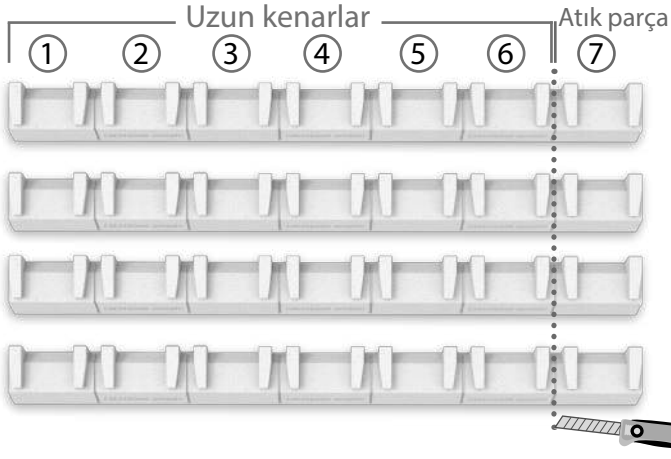
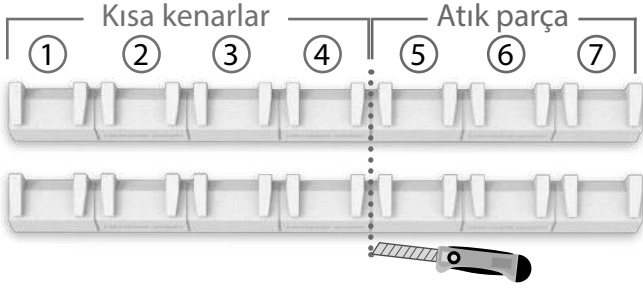

6

Kesilecek
şamandıra

Model L76

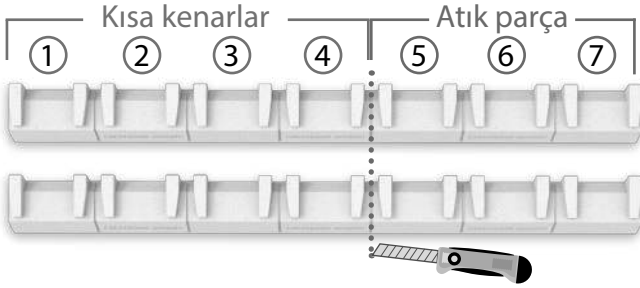

2

Kesilecek
şamandıra

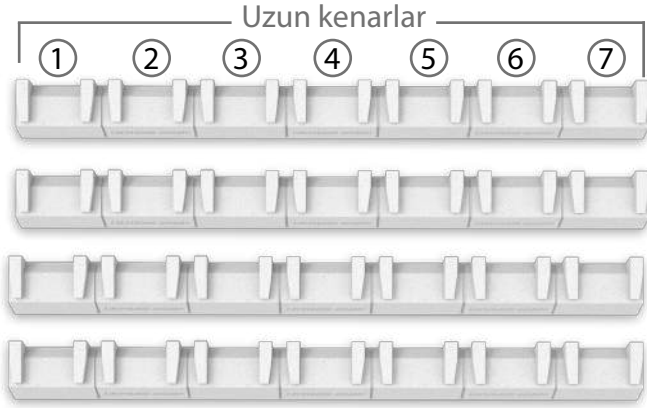

4

Tam
şamandıra

Özel üretim Lucernario Aerante INOX için şamandıra kesimi

Her havalandırma grubu için havalandırma deliği sayısını sayın.

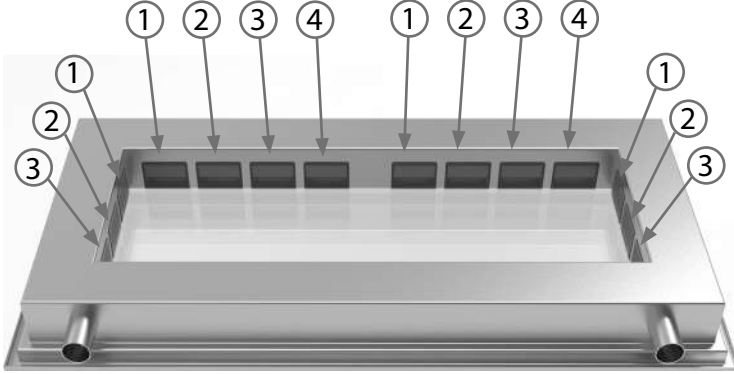

Yukarıdaki örnekte 4'lü ve 3'lü olmak üzere iki farklı havalandırma grubu bulunmaktadır. Aşağıda bir kesme örneği verilmiştir.

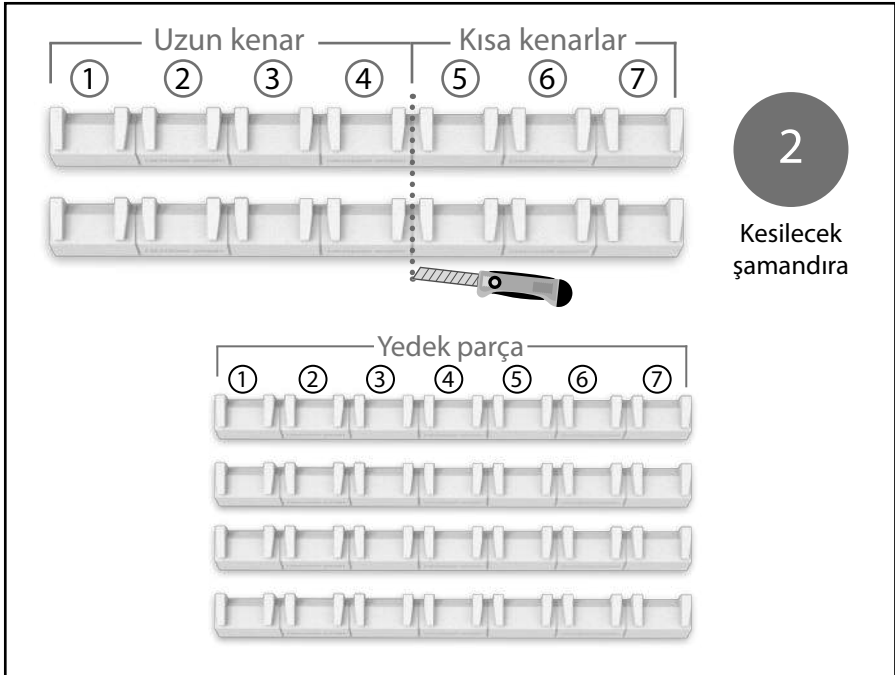

Kurulum

Şamandıra Yerleşimi

Şamandıraları yerleştirirken, düz yüzeyleri havalandırma deliklerine gelecek şekilde yerleştirin. Lucernario Aerante yazısını okuyabileceğiniz şekilde şamandıraları yerleştirin.

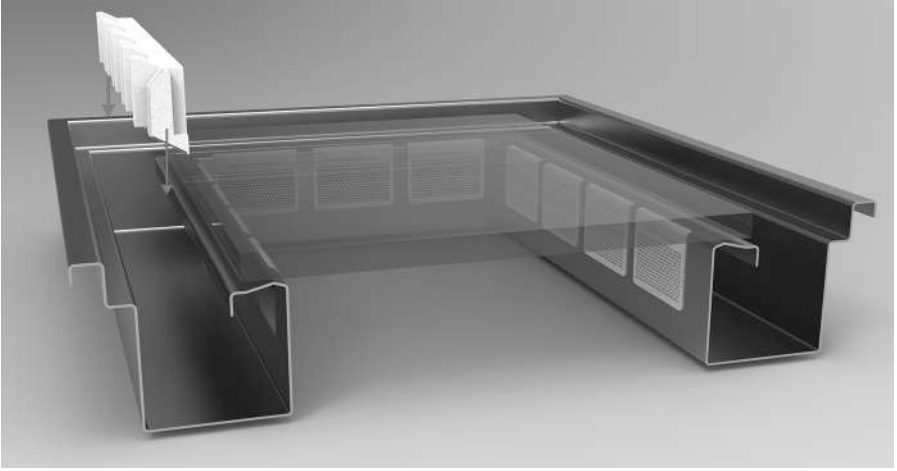

Şamandıraları havalandırma deliklerinin üzerine yerleştirin.

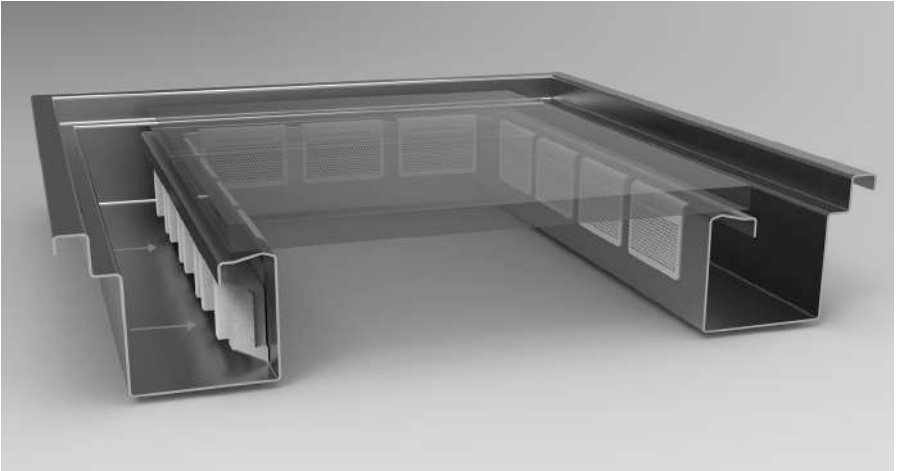

Kılavuz braketlerinin yerleřtirilmesi

Kılavuz braketlerini oluęa yerleřtirebilmek iin eęin

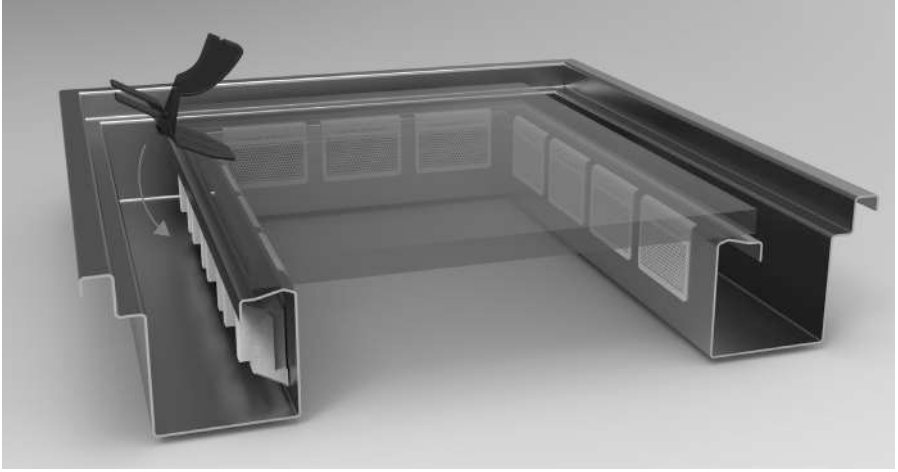

Kılavuz braketleri zerindeki iřaretleri, Lucernario Aerante INOX yapısındaki iřaretlerle eřleřtirin.

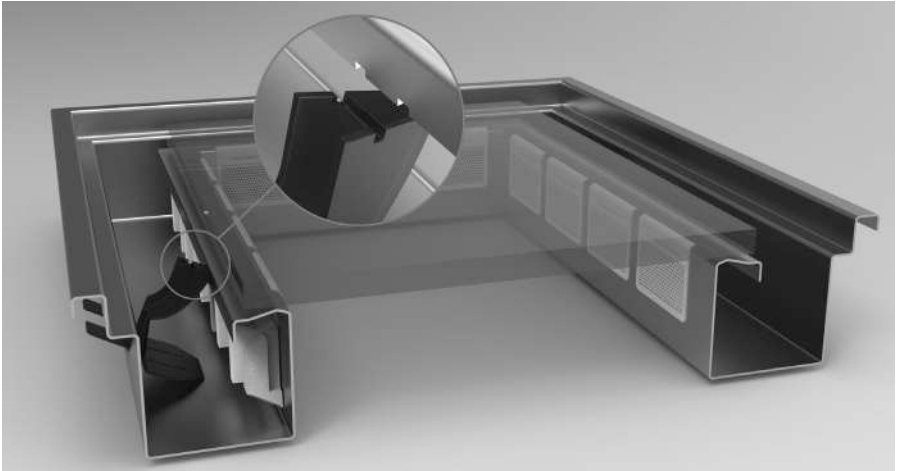

Grazie di aver acquistato ACQUASTOP per Lucernario Aerante INOX.

Il prodotto e il marchio Lucernario aerante® sono proprietà di Bottega del ferro.
Bottega del ferro si riserva tutti i diritti di modificare senza preavviso le caratteristiche dei prodotti riportati.
Questo documento e tutti gli altri relativi ai prodotti Lucernario aerante INOX sono reperibili sul sito
inox.lucernarioaerante.it



Bottega del ferro
Via del Boscone, 8
25014 Castenedolo (BS) Italia
T. +39 030 2731985
info@bottegadelferro.net
inox.lucernarioaerante.it