

Lucernario aerante INOX
For lightwells

Instructions for installers

Security Lucernario aerante for lightwells

INOX series



Instructions for installers

Index

- Page 3 – Supporting base
- Page 4 – Slope
- Page 5 – Before installation
- Page 6 – Procedure
- Page 7 – Illustrations
- Page 9 – Installation diagrams
- Page 10 - Cleaning, Technical support

Important information for correct installation

Read this information carefully before installing the product.

Supporting base

Lightwell by the wall

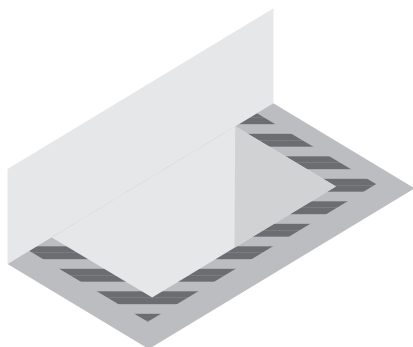

Lightwell away from wall

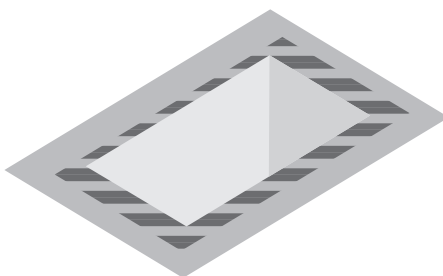

 = skylight support

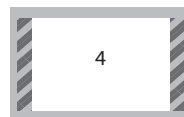

The load-bearing capacity of the *Lucernario aerante INOX* has been tested with a support base of three adjacent sides (figures 1 and 2), but resting on two opposite sides (figures 3 and 4) is also allowed. Please see the load capacity on the Technical Sheet.

Base d'appoggio

YES

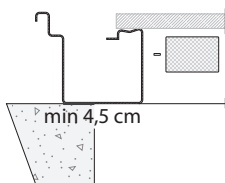

NO

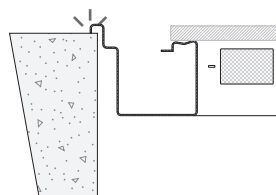

The Skylight must rest on the reinforced concrete over at least 4.5 cm. Any other method of support is forbidden.

Important information for correct installation

Read this information carefully before installing the product.

Minimum slope: 1%

YES

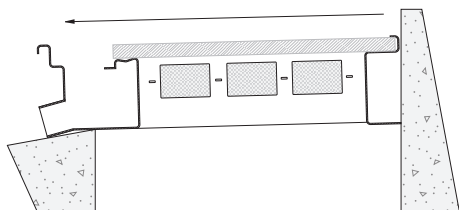

Sloping towards the drain pipes.

NO

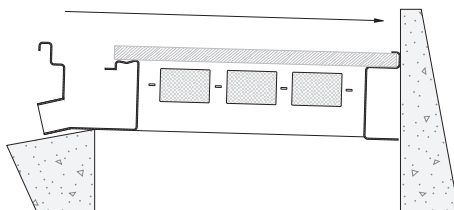

Sloping away from the drain pipes.

WARNING

Lucernario aerante should not be used as a drain grid when it comes to large amounts of water. If necessary, it is recommended to install independent drain channels that allow a rapid water outflow without overloading the *Lucernario*. Non-compliance with these best practices may cause water to pour into the window well.

For further information on the specifications of the product, please see the Technical Sheet.

Instructions for installers

Before installation

- 1) Remove the surface grid and place in a protected area.

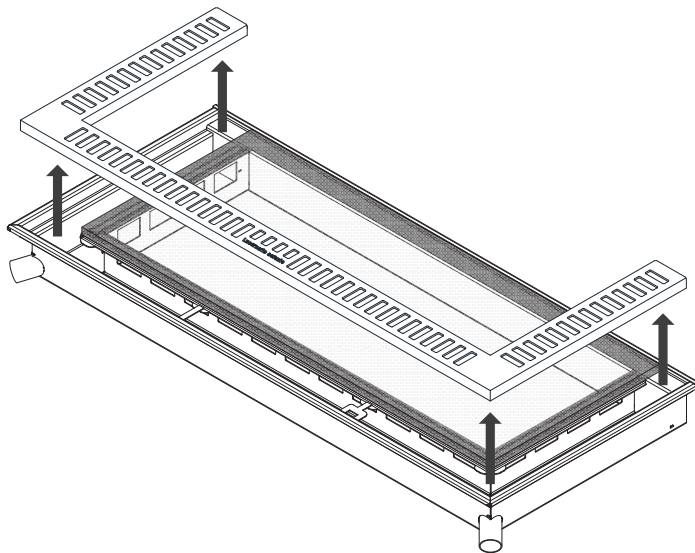

- 2) Protect the glazed surface with cardboard or bubble wrap.

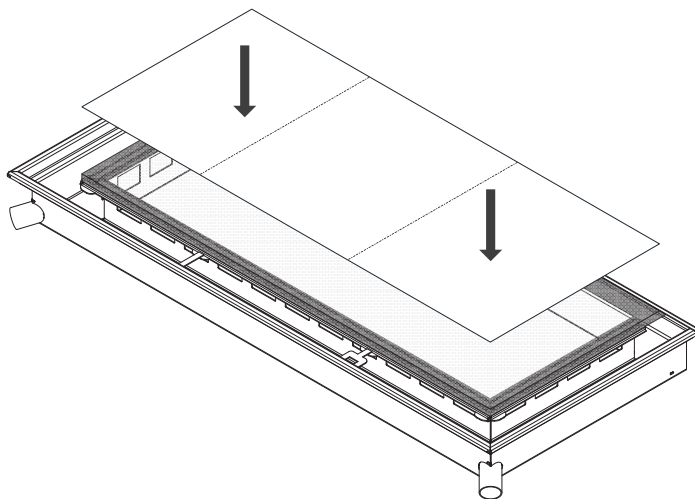

The illustrations may show a different product.

Instructions for installers

Installation

Introduction: *Lucernario aerante INOX* is installed without a subframe (with no predisposition). Its structure is designed to be incorporated into the stratigraphy of the floor. Installation examples are shown on Page 9.

Procedure

1. Position the skylight on the top of the lightwell prepared in the floor slab (see the suggested dimensions in the Technical Sheet).
CAUTION: see the weight of the product on the adhesive label or on the Technical Sheet before moving or lifting.
2. Position the skylight so that the drainpipes are directed towards the lowest part of the flooring (Page 4: Minimum slope).
CAUTION: The presence of the drain does not mean that the drainage channel structure has its own slope towards it, only placing the skylight at the correct angle guarantees smooth evacuation of the channel.
3. Use the necessary spacers to ensure that the surface of the product is equal to the level of the finished floor.
Determine the stability of the support and check that the slope given is adequate.
You can check by pouring a glass of water into the drainage channel and observing the flow.
4. Fix the position of the skylight by compacting the base with reduced-or-no-shrinkage concrete¹. Close any gaps between the floor slab and the skylight.
5. Lay a roll of bituminous sheath on the concrete floor slab and turn it up along the external vertical part of the skylight.
Add further layers of sheath to cover the entire perimeter of the skylight (Fig. A).
6. Heat the sheath to make it adhere to the skylight and the wall next to it (Fig. B).
CAUTION: Do not allow the flame to touch the skylight.
7. Join the sheath on all sides and on the corners of the skylight, taking care to cover every gap to avoid water infiltration (Fig. C).
Do not extend the sheath right to the top of the product to avoid exposing it to the weather: observe the sheath limit (Fig. D).
8. Repeat operations 5, 6 and 7 to apply a second layer of bituminous sheath.
9. Spread a liquid waterproofing product (for example, liquid bituminous sheath) between the sheath and the vertical edge of the skylight, to guarantee the tightness of the sheath during subsequent operations to install the flooring body (Fig. E).
10. Connect a 50 mm diameter polypropylene pipe with seal for each drain on the skylight.
11. Ensure that all stages of assembly have been carried out correctly; wait until the sheath has solidified and then continue with construction of the remaining flooring.
12. Remove the protection from the glass and rest the grill only when work is complete.

¹: We do not recommend using ordinary concrete as it tends to shrink as it dries. In these cases, the skylight could sink lower than the predetermined position. We recommend using specific cements.

Instructions for installers

Illustrations

Fig. A: Laying sheath for installation away from the wall.

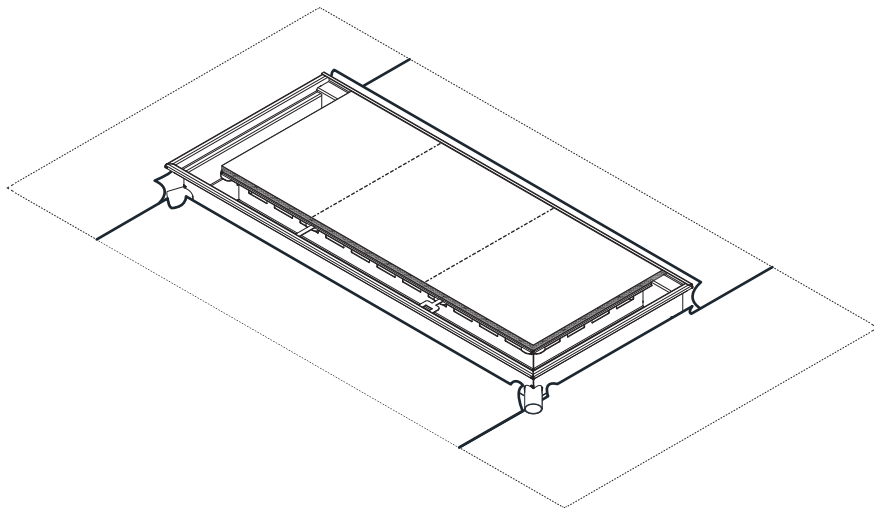
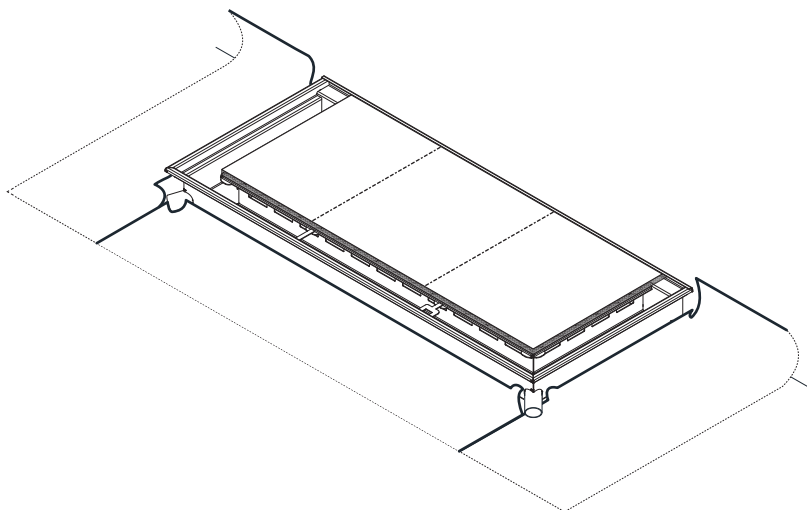

Fig. B: Laying sheath for installation by the wall.



The illustrations may show a different product.

Instructions for installers

Illustrations

Fig. C: Joining the layers of sheath in the corners and around the drain pipes.

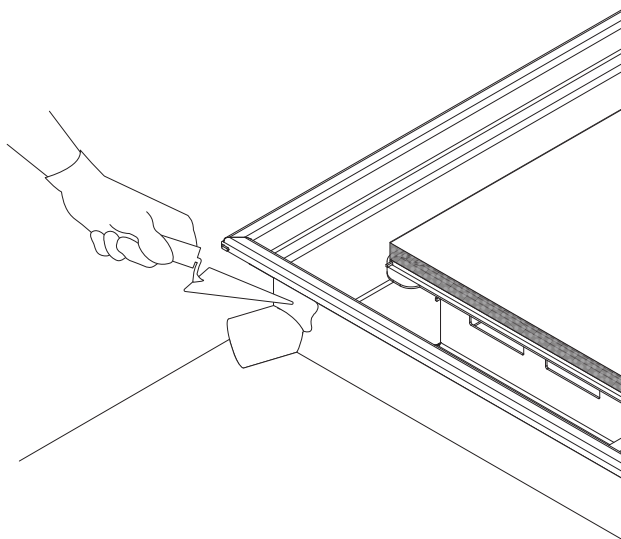

Fig. D: Lay the sheath up to the level shown in the illustration.

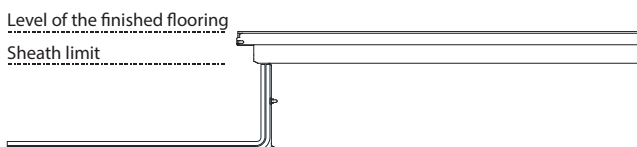
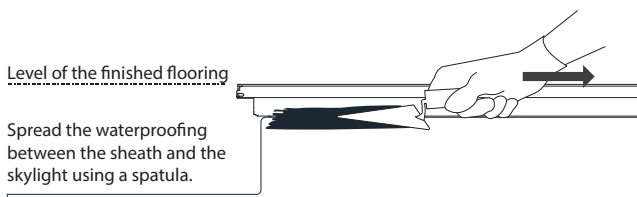

Fig. E: Applying the liquid sheath/waterproofing liquid with a spatula.



The illustrations may show a different product.

Instructions for installers

Installation diagrams

These installation diagrams are provided as an example. We recommend consulting an expert who will define how to create your ideal floor.

Diagram for installation by the wall

For efficient waterproofing:

1. Lay the sheath up against the free sides of the skylight and the wall.
2. Waterproof the gap between the wall and the skylight using a polymer based sealant.
3. Protect the sealing from the weather by applying a skirting board.

CAUTION: It is forbidden to lay cladding, stone cladding or anything else on the glass.

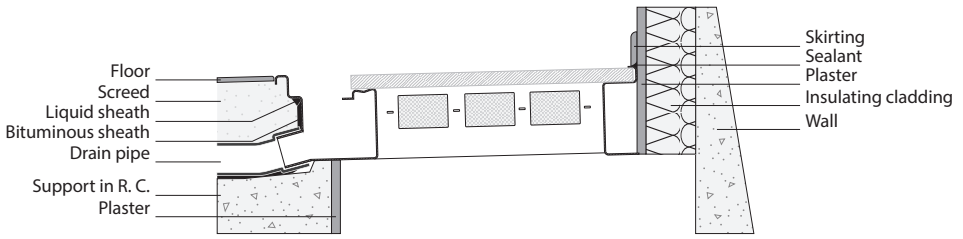
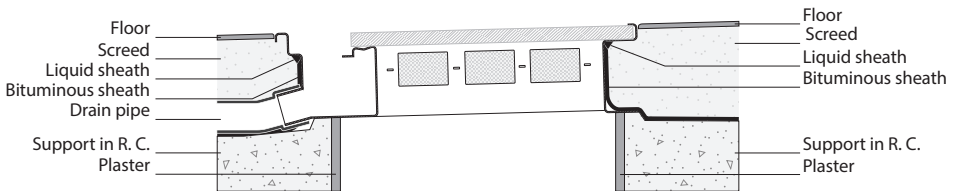

Diagram for installing on a terrace (away from the wall)

Waterproofing with sheath is necessary along all sides.



The illustrations may show a different product.

Instructions for installers

Cleaning

1. Cleaning

Clean the skylight with water.

To maintain the gloss of the finishes, we recommend using neutral products.

Always use protective gloves when cleaning the drainage channel.

2. Forbidden products

We forbid the use of abrasive, corrosive and acid products for cleaning the skylight, such as: bleach, acid substances or those containing acid, thinners, petrol, substances containing chlorine and corrosive substances.

3. Additional notes

Washing with a pressure washer is allowed if the jet is kept at a distance of at least 10 cm.

Technical support during installation

For technical support please contact Bottega del ferro:



Phone: +39 030 2731985



E-mail: assistenza@bottegadelferro.net



WhatsApp: +39 030 2731985

Thank you for purchasing *Lucernario aerante INOX*.

The product and brand *Lucernario aerante*® are property of Bottega del ferro.
Bottega del ferro reserves the right to change the characteristics of the products shown without notice.
This document and all other documents related to the *Lucernario aerante INOX* products can be found on the website inox.lucernarioaerante.it.



Bottega del ferro
Via del Boscone, 8
25014 Castenedolo (BS) Italia
T. +39 030 2731985
F. +39 030 2130930
info@bottegadelferro.net
www.bottegadelferro.net
inox.lucernarioaerante.it